

Temco components  
for manmade fiber processing

**TEMCO**

# Textile Solutions

Components for manmade fiber processing

Customized solutions for  
high efficient processes



# Rieter Components Germany GmbH Temco

Temco offers market-leading components of high quality for the production of filament yarns and synthetic fibers and find versatile application in the textile industry. The components contribute significantly to the quality improvement required in spinning, texturing, draw twisting and draw winding. The products are key elements in the production of synthetic yarns and are used on the machines of all well-known manufacturers in the international textile industry.

The core expertise of the company located in Hammelburg, Germany, are the development, manufacturing and distribution of standard as well as integrated bearing solutions. A team of approx. 160 employees is responsible for the design, manufacturing and worldwide distribution of customized bearing solutions. In the Chinese market, a local sales team reinforces the headquarter. Temco aims to guarantee its worldwide customers the highest level of service combined with technical expertise. The company provides a comprehensive end-to-end solution of products including their rolling bearings, interlacing jets, texturing discs, texturing cots & aprons and twist stoppers.

The bearing expert also develops, produces and sells high-performance components specially tailored to its customers in other sectors, such as the hygiene, lithium battery and packaging industries.

## Content

4	Bearing technology
6	Product portfolio
8	Processes overview
10	Guide rollers FR
18	Journal bearings SL + ZL
24	Separator rollers VR
34	Supporting rollers SW
40	Twist stoppers DST
46	Nip rollers LR
54	Bearing assemblies LAG
60	Texturing discs PU
76	Texturing unit FTS
84	Air interlacing jets LD
96	i-Bearing

# Temco Bearing Technology

Since 1957 – at that time still as part of FAG Kugelfischer – the company has been developing, producing, assembling and distributing high-performance components for the most renowned textile machinery manufacturers worldwide. Even though the company has gone through several name changes since then, one thing has not changed since 1957: the pioneering spirit.

## Advantages of Temco bearings

- More compact housings
- Low starting torque, smooth running, energy saving
- Ready-to-install solutions
- Reduced number of fits
- Higher limiting speeds compared to standard roller bearings
- Application-specific lubrication
- Superior sealing
- Higher rigidity of the whole system (shaft, housing)



To reduce the budget for spare parts without sacrificing quality or to shorten machine downtime due to maintenance work or the replacement of wear parts, Temco bearing supports are the ideal solution. The integrated bearing concept for high-end applications is very successful. Integrated bearings enable the implementation of highly economical solutions for applications with a demand for highest speed, limited installation space or heavy load.

Conventional bearing constructions mostly use standard bearings. In these constructions two standard bearings are put between shaft and housing. This kind of constructions are limited considering speed, lifetime and starting torque. Therefore the bearings used in these constructions in most cases have to be replaced regularly.



Standard bearing

By integrating the inner raceway into the shaft and the outer raceway into the housing a very compact and stiff bearing construction is achieved. This provides a lot of advantages. Most important is the possibility of adapting the inner bearing design to the customer application:

- higher load rating than standard bearing of the same size or
- less friction than a standard bearing of the same size
- reduced size with the same load rating as the standard bearing

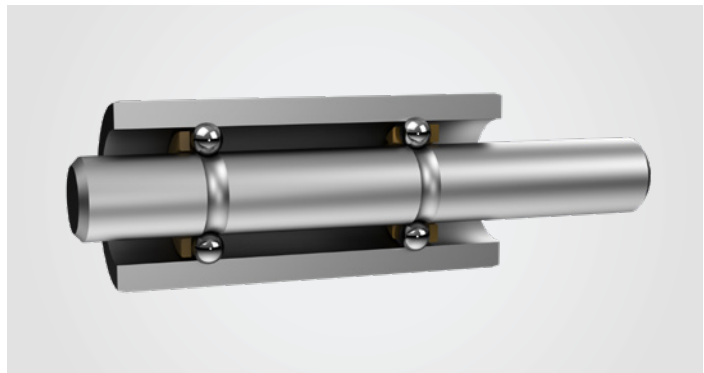

Integrated bearing

## Benefits for customers

- Running characteristics optimised for the customer´s requirements
- Lubrication adapted to the working conditions such as speed, temperature, load or torque
- If required, a better sealing against dirt or liquids
- Additional functions are possible, e.g. pulleys, connecting adaptors, gearings, excentrics or damping
- Temco also provides whole assemblies

# Temco Textile Product Portfolio

Process	Bearings				
	Guide rollers FR	Journal bearings SL+ZL	Separator rollers VR	Supporting rollers SW	
	Filament spinning process (POY/FDY)	■	■	■	
	Spinning process carpet yarns (BCF)	■		■	
	Texturing process			■	
	Winding process	■		■	■
Glass fiber spinning process					



# Product

Bearings					Air interlacing	i-Bearing
Twist stoppers DST	Nip rollers LR	Bearing assemblies LAG	Texturing discs PU + Cool Flow + GreenDisc	Texturing units FTS	Air interlacing jets LD	i-Bearing wireless
					■	■
					■	■
■	■	■	■	■		■
						■
					■	■



# Textile Processes



## ■ Filament spinning process (POY/FDY)

In the production of man-made fibers, spinning pumps press the plastic melt through microfine spinnerets under extremely high pressure. The resulting filaments are bundled into threads, drawn over godets and wound up by a winding head. Temco components support the spinning process reliably and with high quality over a long period of time.



## ■ Spinning process carpet yarns (BCF)

The production of BCF carpet yarns is associated with high quality and efficiency requirements for the carpet industry. Temco's products meet the demanding challenges of the production of BCF carpet yarns.

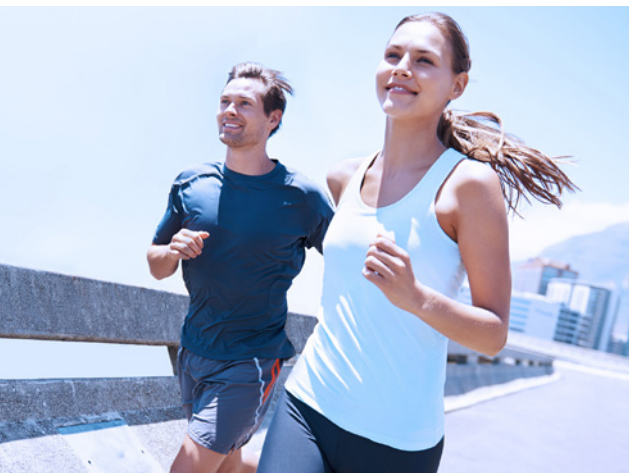

## ■ Texturing process (DTY)

Home textiles, clothing and vehicle interiors: there are countless applications for textured yarns produced with Temco components. Accordingly, the requirements for the yarns used are specific. Temco products ensure optimum process stability at high yarn speeds and excellent yarn quality.



## ■ Winding

For the winding process of filaments, but also other materials such as wire or glass fibers, Temco offers a wide range of products for a precise process flow. The rewinding machines and bobbin winding machines in various designs for different bobbins and bobbin sizes are optimally equipped with Temco components so that the processed materials can be spooled, rewound and wound up stress-free.



## ■ Glass fiber

Glass fibers are used as optical fibers for data transmission and flexible light transport, as rovings or as textile fabrics and for glass fiber reinforced plastics. To give them the properties they need for further processing, Temco products are tailor-made and particularly suitable. They thus create the appropriate conditions to meet customer requirements in the glass fiber industry.

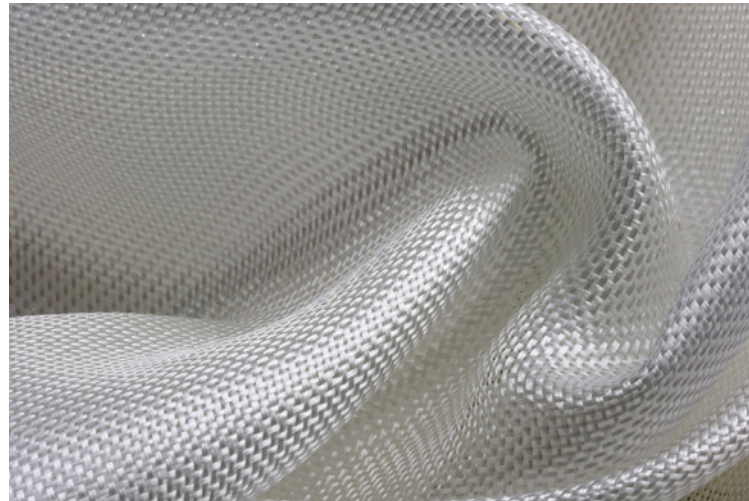



# Guide Rollers FR Series



# Smooth Running for Thread and Tape Guidance

Low tension forces and yarn deflections as well as gentle yarn guiding characterize the Temco guide rollers FR. These bearings are used in many machine applications.

The extremely smooth-running guide rollers are suitable for all processes, where low tension forces and gentle yarn guidance are required. The portfolio of guide rollers guarantees smooth running for thread and tape guidance in textile and technical applications. Temco guide rollers are distinguished by low start-up and running friction torque, which makes speeds up to 6 500 m/min achievable. The bearings are used in various applications, like in production of baby diapers and many more.



# OUTSTANDING

## ADVANTAGES

# Guide Rollers FR

Very Smooth Running  
due to the Integrated  
Bearing Construction

Considerably Longer Service  
Life due to the Modified  
Bearing Construction and Wear  
Resistant Ceramic Coating



Applicable up to 6 500 m/min  
Without any Restriction

Uniformly Low  
Friction of the Bearing  
Guarantees High Yarn  
Processing Consistency

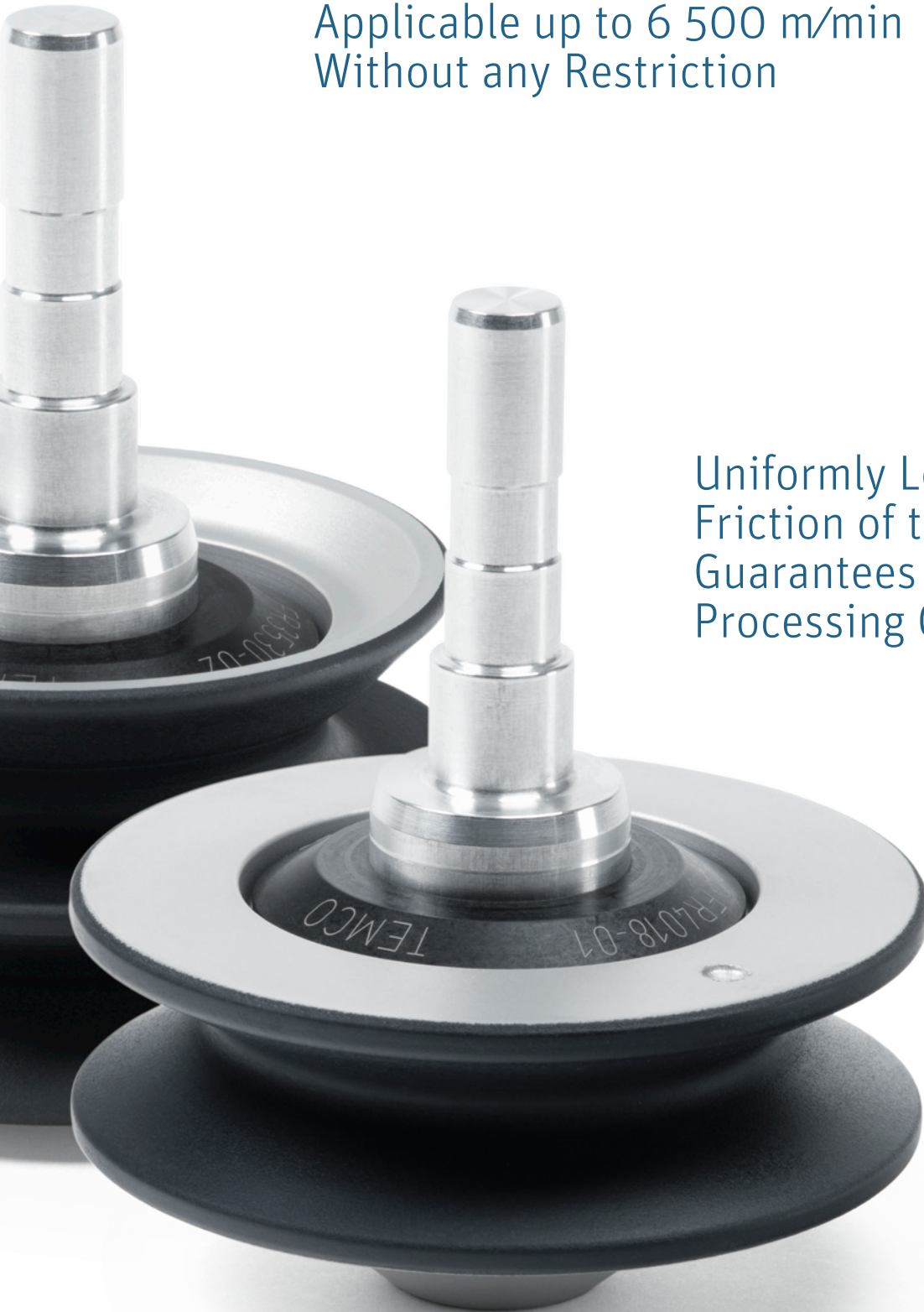

# Temco Guide Rollers FR35 and FR40

## Product features

Temco guide rollers come in various shell shapes and materials and are equipped both with or without a shaft. They are characterized by their compact building method with low rotating mass and low bearing friction moment. Yarn speeds of up to 6 500 m/min are possible.

The lubricant has been specially selected to satisfy the requirements of guide rollers, thus ensuring smooth running and long lifetime. The guide rollers are equipped with a special dust shield cover on either end.

The shells are made of steel, aluminum or innovative synthetic material. For special applications, guide rollers with chromium-plated or ceramic-coated shells are available.

## Advantages

Smooth-running yarn guide rollers are available to guide threads and tapes in textile and technical applications.

The extremely smooth-running yarn guide rollers FR3530-02 and FR4018-01 and FR4030 are especially suitable for all processes where low tension forces or low yarn deflections and gentle yarn guiding are required.

Guide rollers FR include various jacket shapes and materials and are equipped with or without a shaft. They are characterized by their compact building method with low rotating mass and low starting and bearing friction moment.

## Area of application

The extremely smooth-running yarn guide rollers are suitable for all processes, where low tension forces and gentle yarn guiding are required. The most important applications are in high-speed processes like the spin draw texturing process of Bulk Continuous Filament (BCF), the Fully Drawn Yarn (FDY), or the Spin Drawn Yarn (SDY) process for technical yarns.

Temco's extremely smooth guide rollers are also suitable in filament production for geotextiles, where low tensile forces and gentle yarn guidance are required.



# Temco Guide Rollers FR26 Series

The latest generation of the smooth-running guide rollers FR26 Series are a milestone in the field of easy running guiding elements. Bearing friction is reduced by 50%, therefore the driving force is reduced by the same extend enabling guidance of e.g. Lycra at a very low tension level.

## Product features

In addition to the standard shapes, intermediate sizes and customized solutions of the guide roller series FR26 are also available.

Benefits:

- Reduced yarn tension
- Smooth running
- No initial run-in period required
- Low moment of inertia
- Long service life
- Different roller shell forms
- Variable surface coatings

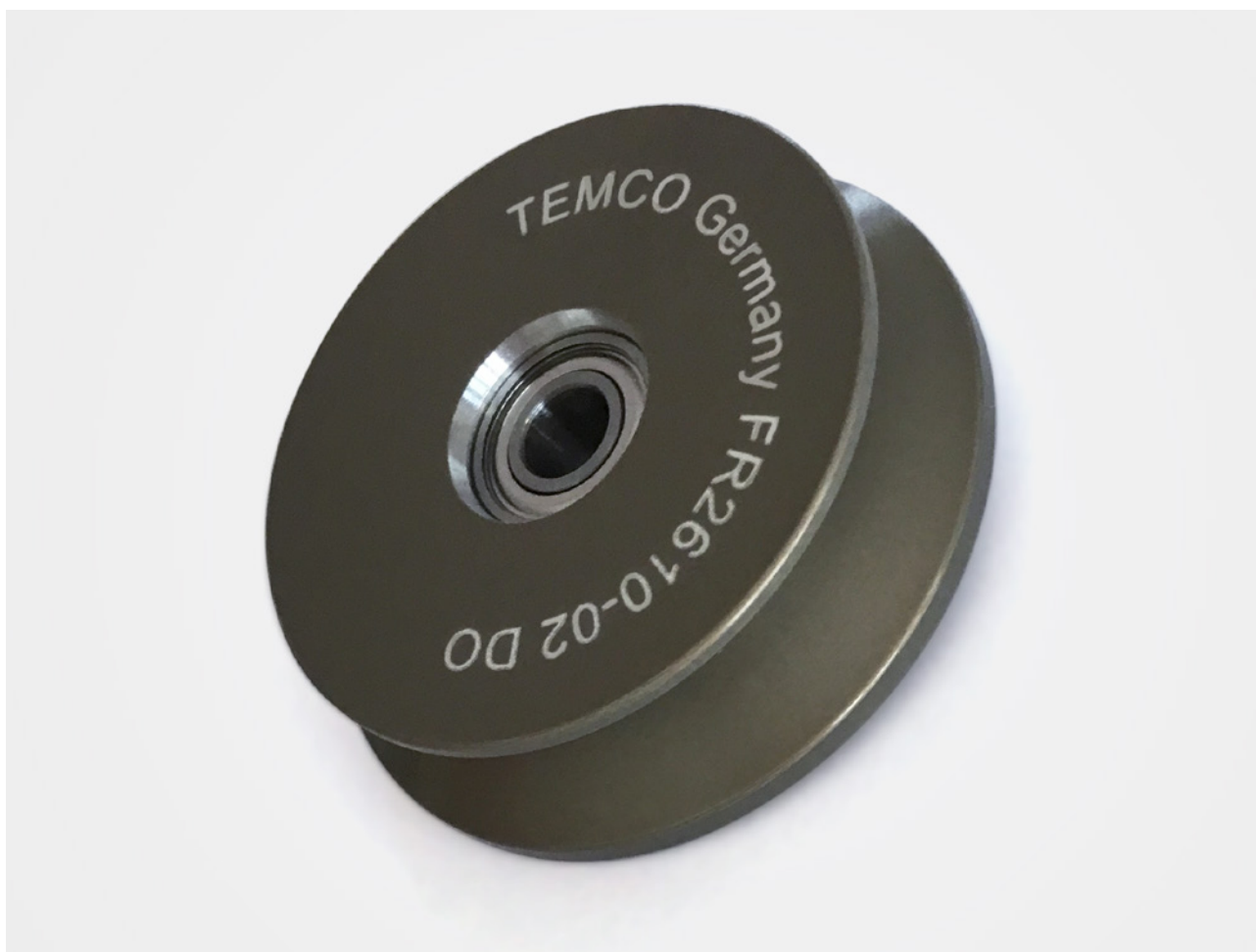

# Guide Rollers FR Series

## Easy and smooth running

The bearing friction torque and the particularly important yarn tension are reduced by more than 50% compared to our proven yarn guide rollers. Precise manufacturing processes, coupled with appropriate monitoring, ensure a high level of position uniformity, i.e. the drive forces of neighboring yarn guide rollers lie within the narrowest possible bandwidth.

## Comparison of run-down-times

Practical proof of the enormous reduction in frictional torque can be provided by comparing the run-down-time. The significantly higher run-down-time of the next FR26 generation demonstrates the influence of the new bearing design on the smooth running properties.

**Bearing friction torque**

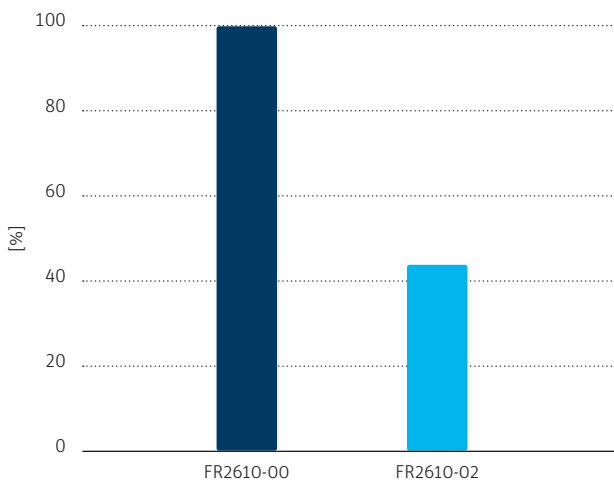

Mathematical consideration of both FR2610-0X types

**Rundown-time**

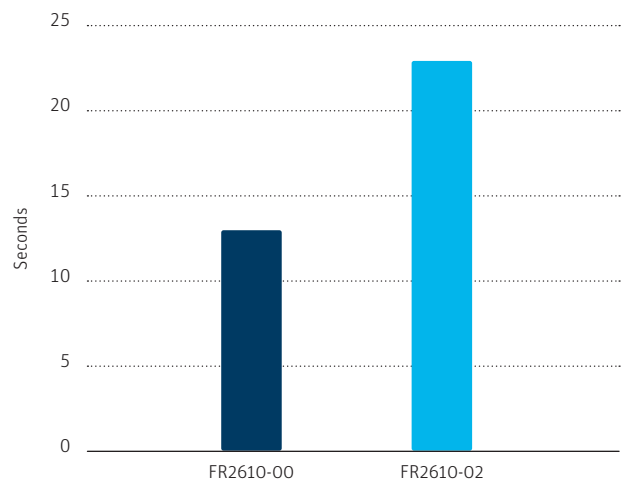

Comparison of the rundown-times of both types yarn guide roller generations



# Guide Rollers FR26 Series

## Reduction of yarn tension

Based on the 50% lower bearing friction, the necessary drive force is also reduced to the same extent, which allows a deflection of Lycra threads at a very low tension level. Compared with the previous Temco yarn guide rollers already established on the market, the yarn tension level could be halved again.

## Ready for immediate use

The new generation of yarn guide rollers are already subject to a bearing run-in at Temco, which means that by bringing it into service their yarn tension level during operation is only marginally reduced. Excessive tension associated with bearings without initial run-in can be avoided, resulting in higher quality production for example in the elastic waistband of a diaper.

## Highlights

Roller shells with a reduced mass facilitate the fast acceleration of the yarn guide roller from standstill with minimal increase in yarn tension.

Accurate manufacturing and consistently process monitoring are the basis for a long lifetime.

The FR26 is available in different roller shell forms. In addition to the standard forms, intermediate sizes and customized solutions are available.

Surfaces:

- Anodized coating (available in different colors)
- Hard chrome coating
- Plasma layer (non-stick coating)

Yarn tension force in comparison

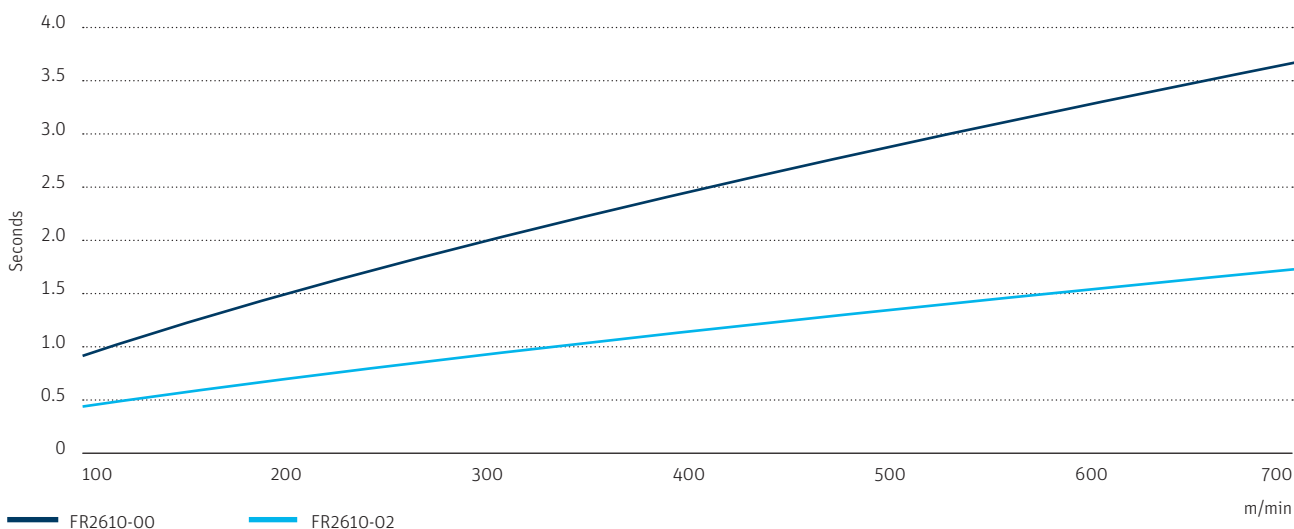



# Journal Bearings SL



# Ready to Use

Small, ready-to-use bearings for high standard spinning processes. Single-sided, double-sided or without shaft, lubricated for life or relubricatable – Temco ball bearing units are as diverse as their application.

The main characteristics of the journal bearings SL and ZL are their pre-finished, compact design. When equipped with a jacket, these bearings are, for example, suitable as guide or deflection rollers or serve as tension pulleys. They are suitable for a wide application range. SL journal bearings are equipped with an open axis or shaft end. ZL feature a double-sided axis or shaft end. Shafts and housings are available in all standard dimensions. In addition, their dimension can be adapted to satisfy individual space requirements.



**OUTSTANDING**

ADVANTAGES

# Journal Bearings SL

Compact and Ready-  
to-Install Design



Wide Range  
of Applications

Various Common  
and Special Custom  
Dimensions



# Journal Bearings SL and ZL

## Expertise

Temco journal bearings are double row deep groove ball bearings. The inner raceways are integrated into the shaft while the outer raceways are integrated into the housing. The sealing system is adapted to the specific application. Some models of the journal bearings are lubricated for life, others are suitable for relubrication. The selection of product and lubricants depends on the application.







# Separator Rollers VR





# Guiding and Deflection

Temco has developed and produced separator rollers for more than 50 years. Originally, they were used for yarn guidance, drawing and thread-path wrap angles on draw-twisting machines. Today, Temco's separator rollers are used in a broad range of applications, and in some of the most diverse processes.

To satisfy these applications, not only knowledge and experience in low-friction bearing manufacture are necessary, but a high degree of competence and authority concerning the production and subsequent treatment of synthetic yarns and textiles are of paramount importance.

In principle, separator rollers serve to support the production process without any negative effect on yarn quality. The bearings used must be of the highest quality to ensure low friction moment, durability and stable running. The majority of the Temco separator rollers are available with fitments suitable for the most commonly used textile machines.



# OUTSTANDING

## ADVANTAGES

# Separator Rollers VR

Maximum Lifetime due  
to Optimized Bearing  
Load Capacity

Yarn Gentle  
Roller Shells





Corrosion  
Resistance

Ensure Stable  
Running

Use of High  
Quality Bearings

# Guiding and Deflection of Continuous Materials

## Influence of yarn count

With fine yarns, low starting moment of the separator roller must be ensured so that there is no loss of adhesion with the roller surface on start-up. Loss of adhesion brings about yarn slippage, which intensifies wear on the separator roller surface and can cause filament damage. A small rotating mass of the separator roller and low friction moment of the bearing guarantee a low starting moment. With coarser yarns, strong radial forces can adversely affect the separator roller. By use of a suitable bearing construction, Temco optimizes the bearing load capacity for each respective application. Thus, the lifetime of the separator roller is maximized, despite the high demands imposed on it.

## Surfaces

Particularly high demands are imposed on separator roller surfaces, which must be corrosion resistant against the various qualities of spin preparation types. Temco's selection of high-quality materials and coatings, together with special manufacturing methods, guarantees the necessary corrosion resistance. The surface characteristic of the separator roller must not damage the yarn; simultaneously, the coating surface must have sufficient roughness to avoid any single filament adherence to its surface. This is achieved by the orange-peel surface effect of high-quality hard chrome alloys and particularly abrasion resistant ceramic coatings.



# Separator Rollers in the Production Process

## Draw twisting and draw winding

Depending on the application, yarns are processed at cold or hot temperatures (up to 260°C) and at yarn speeds up to 2 000 m/min. The task of the separator roller in the drawing zone is to separate the individual yarn wraps. With this, the separator roller replaces the second of the two godets. The separator roller must be temperature resistant and, due to the high yarn speeds, must exhibit low vibration at high rotational speeds. The separator rollers easily absorb the strong radial forces resulting from the drawing operation.

## Texturing

Separator rollers are used on many texturing machines for yarn separation at the yarn feed systems. Here, the smoothness of operation and durability are the most important criteria for separator rollers, since they are neither subjected to high temperatures or very high yarn speeds. For the processes described above, Temco offers a broad range of separator rollers in various designs to meet all customer requirements.

## Spin-draw-texturing (BCF process)

With this process, yarn temperatures on the separator rollers can reach up to 140°C.

For fine polyamide yarns, yarn speeds are up to 5 000 m/min. Temco Separator Rollers are used in several positions in the process and have different functions. In combination with the godet, they have the same task as in draw-twisting (see above); they also form a yarn wrap in the yarn path in front of the air jet and cooling drum.

The extremely high yarn speeds during the process impose the highest demands on running stability and smooth operation of the separator rollers used. Occasionally, the bearings must withstand high draw forces. The stability of the bearing construction is, therefore, also an important factor.



# Wide Range of Various Products

## Series VR22

The separator roller series VR22 are produced for speeds up to 5 000 m/min. The separator rollers have been developed for spin processes at low yarn temperatures (up to max. 70 °C) and high speeds.

### Dimensions (mm)

Length of the roller shell	58.0 – 120.0
Total length	75.0 – 137.0
Length of the connection journal	14.5 – 25.0
Diameter	22.0



## Series VR30, VR36, VR40

The separator roller series VR30, VR36 and VR40 are produced for speeds up to 2 000 m/min. The separator rollers can be used for spin processes with very high yarn temperatures up to maximum 260 °C.

### Dimensions (mm)

Length of the roller shell	77.0 – 110.0
Total length	97.0 – 137.0
Length of the connection journal	14.5 – 24.0
Diameter	30.0/36.0/40.0



## Series VR50

The separator roller series VR50 are produced for speeds up to 4 500 m/min and as special design for speeds up to 6 000 m/min. The separator rollers have been developed for spin processes POY/FDY/SDY (technical and non-technical yarns) and spin draw texturing BCF (for carpet yarns), which can be used for yarn temperatures up to 160 °C.

### Dimensions (mm)

Length of the roller shell	150.0 – 245.0
Total length	215.7 – 285.0
Length of the connection journal	40.0 – 64.5
Diameter	50.0



## Series VR60

The separator roller series VR60 are produced for speeds up to 4 500 m/min and as special design for speeds up to 6 000 m/min. The separator rollers have been developed for spin processes POY/FDY/SDY (technical and non-technical yarns) and spin draw texturing BCF (for carpet yarns), which can be used for yarn temperatures up to 160 °C.

### Dimensions (mm)

Length of the roller shell	238.0 – 320.0
Total length	278.0 – 360.0
Length of the connection journal	40.0
Diameter	60.0



# Separator Rollers in the Production Process

## Yarn speed and temperature

Important factors in the design of separator rollers

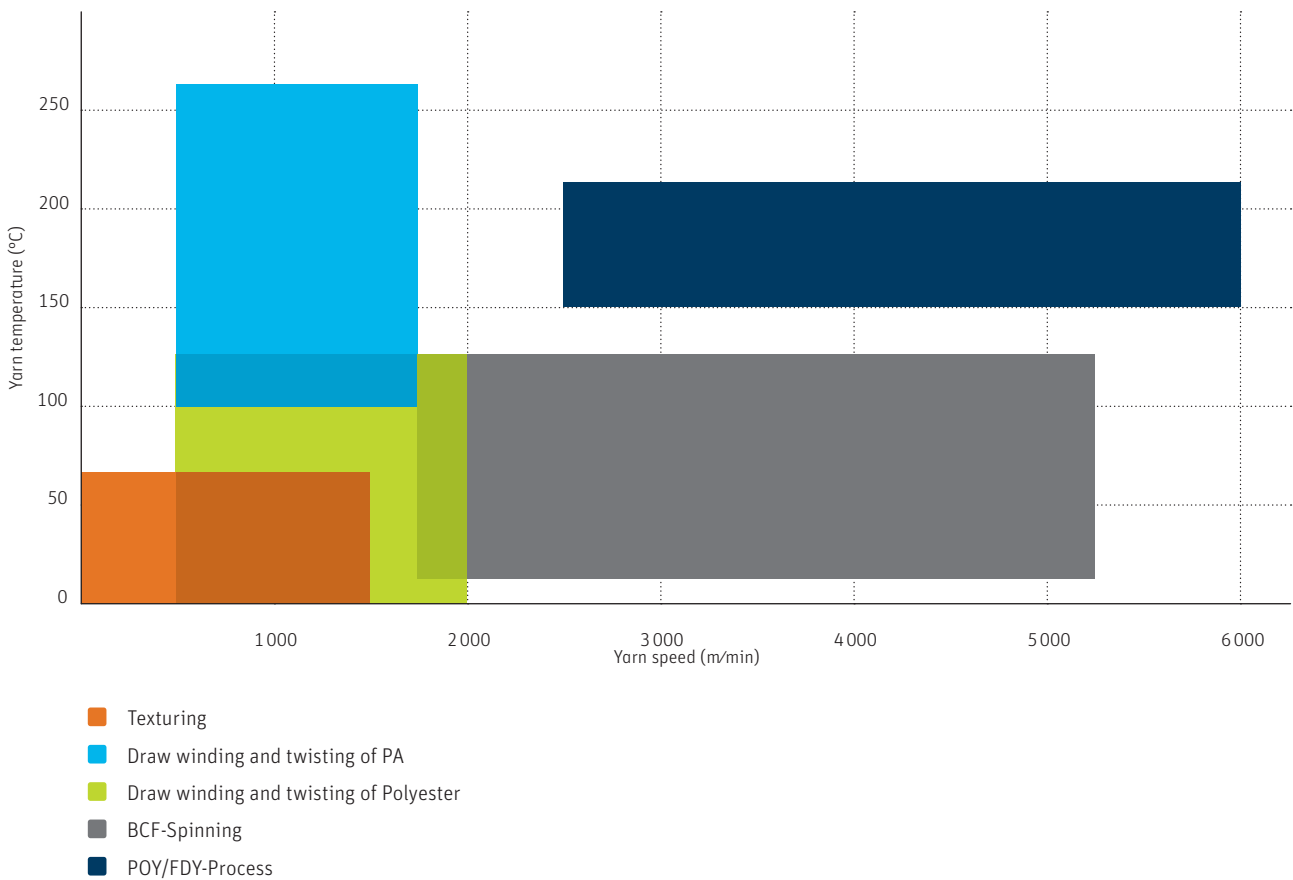



# Next Generation of Separator Rollers

To meet the demands of the market, Temco has generated a new generation separator roller through continuous development of the proven separator rollers with different roller diameters and various dimensions.

## Features

The lifetime lubrication, which is tuned to the use, has already been proven for years and ensures smooth running even at very high speeds. The bearing is equipped with clearance seals and lids which prevent an air flow and the penetration of dirt securely.

## Advantages

Due to the newly developed bearing damping with prestressed integrated bearing following characteristics could be achieved:

- Up to 85% higher speeds in comparison to the previous designs
- Resonance free running
- Applicable for up to 50% higher yarn tension forces in comparison to the previous designs
- Lower bearing friction and therefore less slippage of the yarn





# Supporting Rollers SW



# Deflecting and Guiding

Temco supporting rollers – the perfect support for all yarns in winding machines. Individual designs and a speed of up to 50 000 rpm make the Temco SW an important component in the textile industry.

Supporting rollers SW are manufactured in all standard designs and dimensions. Their construction is optimized to satisfy all application requirements of the individual winding machine. They are suitable for speeds of up to 50 000 rpm. For the integrated bearing design, the raceways are incorporated into the shaft; other models are equipped with deep groove ball bearings.



**OUTSTANDING**

ADVANTAGES

# Supporting Rollers SW

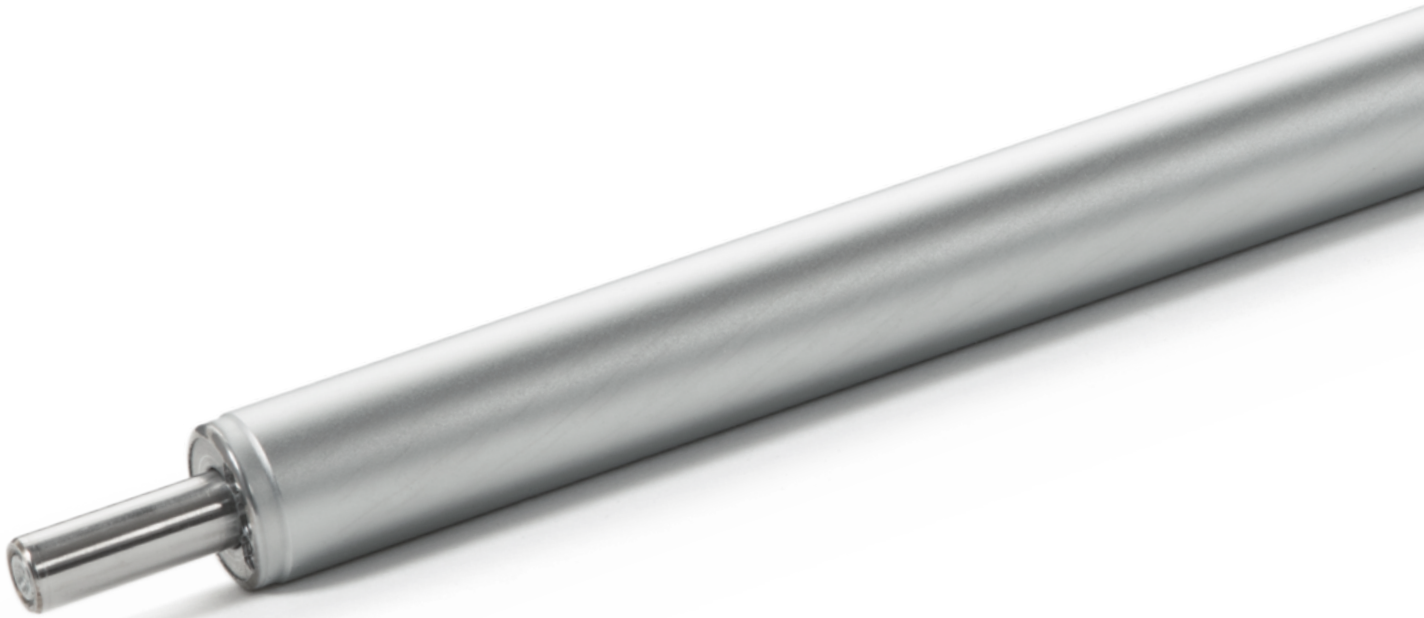

Long Service Life

Lifetime Lubrication

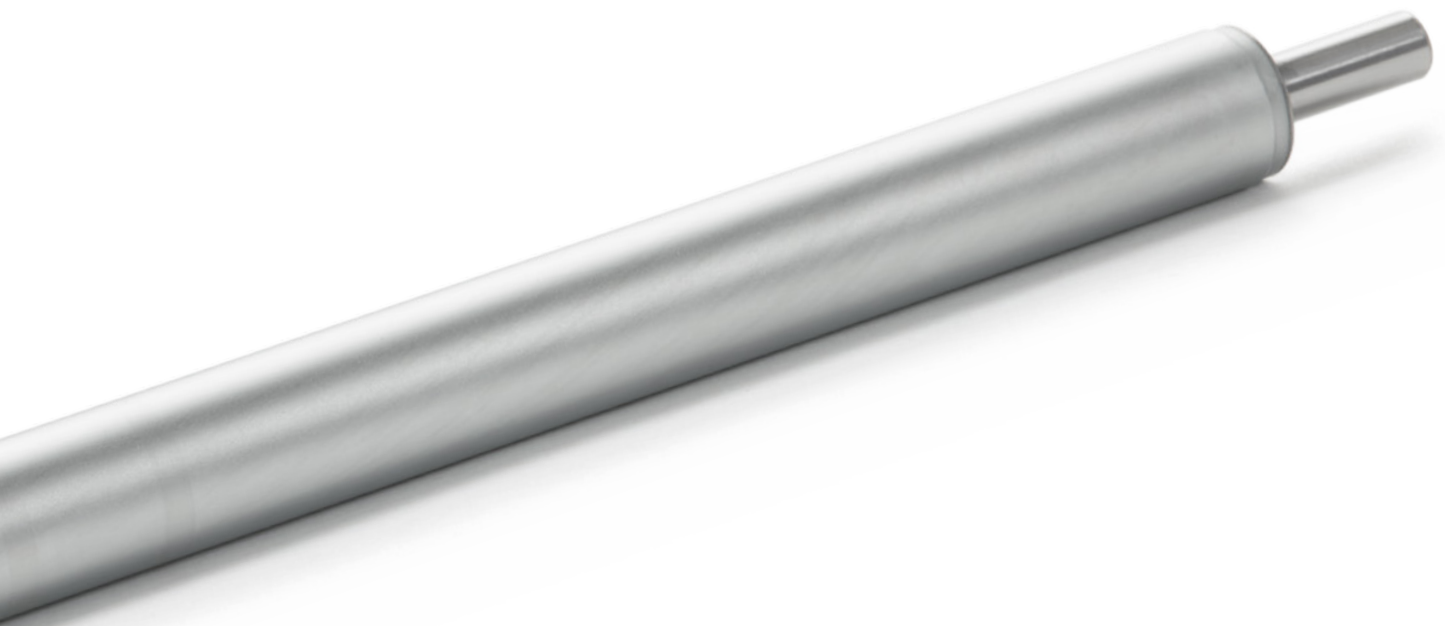

High Load Capacity with  
Small Installation Space Size



# Supporting Rollers SW

## What to expect

### Product features

- All supporting roller models are provided with lifetime lubrication. The supporting rollers are equipped with a non-contact gap-type seal on either end.
- The roller shells are made of steel or aluminum. The chromium plated roller with an orange peel effect surface ensures good frictional conditions.

### Area of application

Supporting rollers are used to support yarn on winding machines. Low weight, reduced eccentric mass and hard chrome coatings are their main characteristics.





# Twist Stoppers DST



# Filament Friendly for Highest Yarn Quality

Based on the experience as the technology leader in texturing, Temco has created its advanced ceramic twist stoppers DST. Nearly all texturing machines are equipped with twist stoppers in front of the first heater. The range of application covers all yarn counts, profiles and lustre, for any type of textured yarn.



# OUTSTANDING

## ADVANTAGES

# Twist Stopper DST

High Precision  
Ball Bearings

Low Friction



High Process  
Stability

Low Inertia



# Twist Stoppers DST

## Expertise

Temco is a competent partner to the textile industry and offers its advanced ceramic twist stoppers for all applications. The double-row bearing of the twist stoppers offers several advantages over single-row designs, such as stable running behavior and long service life.

Thanks to the novel and patented snap-fitting of the ceramic twist stoppers and the simple assembly tools as well as the detailed instruction manual a fast and easy assembling and maintenance of the twist stoppers is ensured.

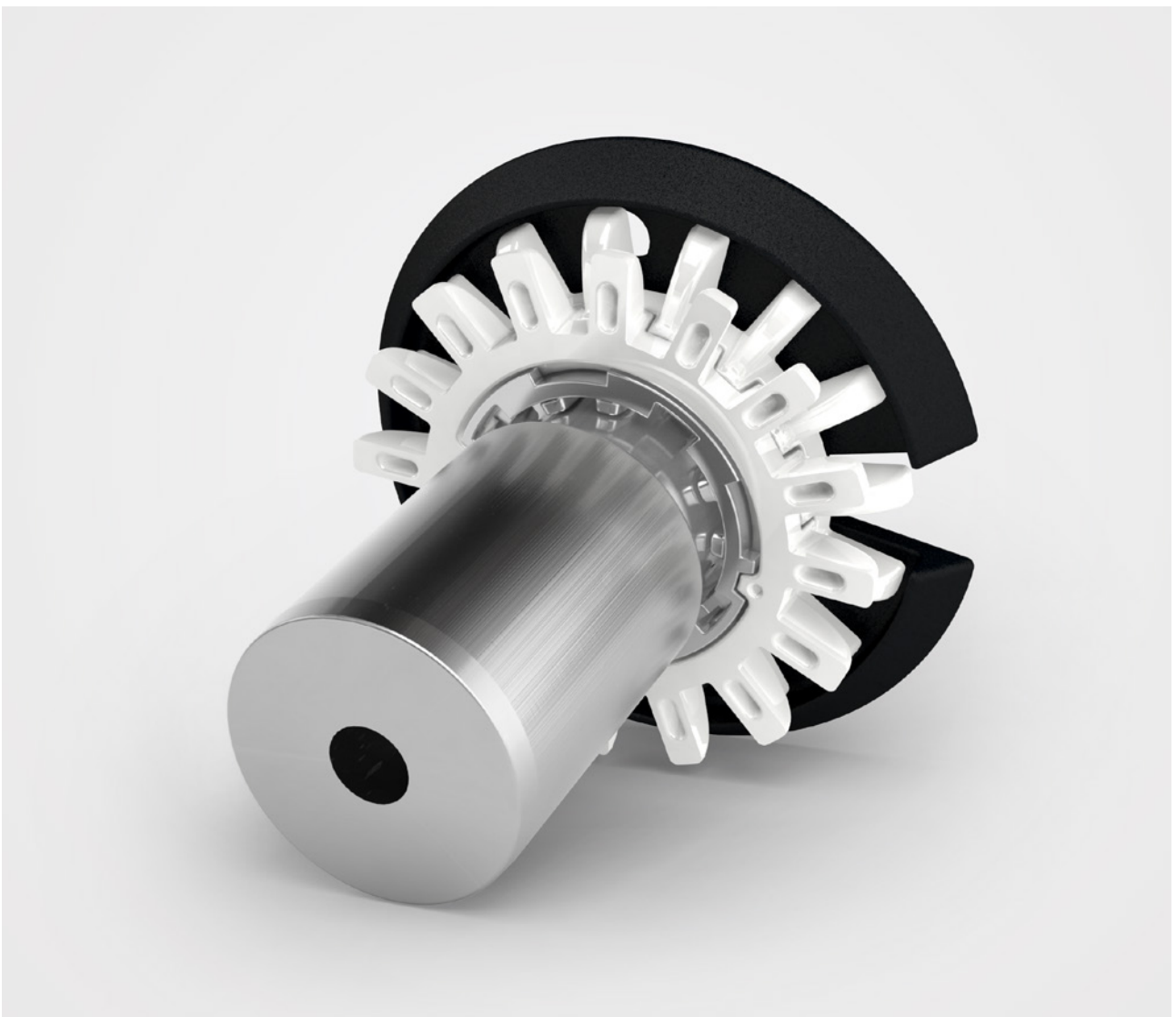

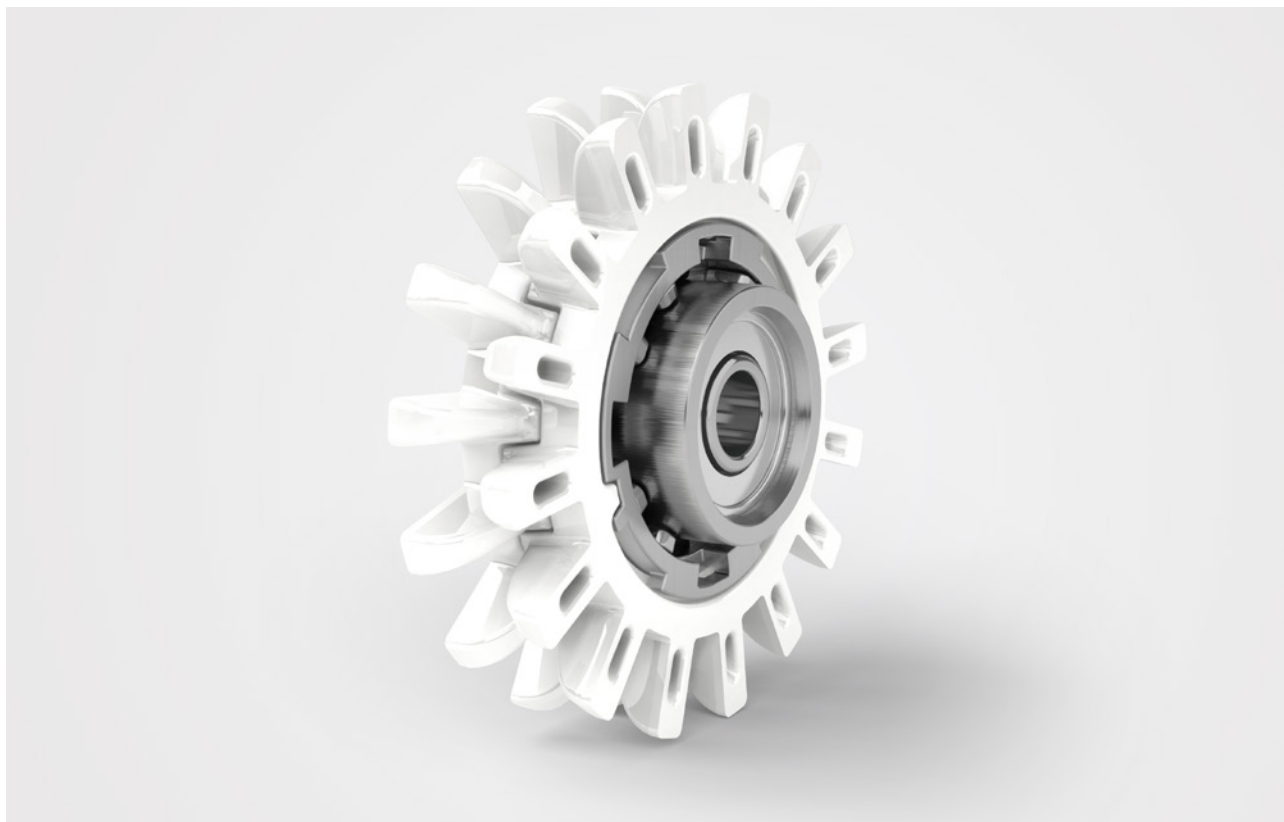

## Product features

- Star wheels made from diamond-polished advanced ceramic prevent any microfiber damages
- Low inertia reduces tension peaks during start-up
- High precision ball bearings for unsurpassed lifetime
- Low friction – no additional tension for constant yarn quality
- Highest process stability based on undisturbed yarn flow and secure, but smooth twist stop
- Fast and secure replacement of star wheels or bearing – assembly with snap-fit, no screws
- Easy and efficient cleaning and removal of yarn wraps
- Suitable as original equipment or retrofit for all existing types of texturing machines

## Area of Application

For stabilization of the texturing process, nearly all modern texturing machines are equipped with twist stoppers in front of the first heater. With Temco twist stoppers both polyester (PES) and polyamide (PA) yarns are gently treated in the titer range from dtex 22 to dtex 167. The range of application covers all yarn counts and profiles for any type of textured yarn. The Temco twist stoppers are suitable for both new equipment and retrofitting of all existing machines on the market.



# Nip Rollers LR

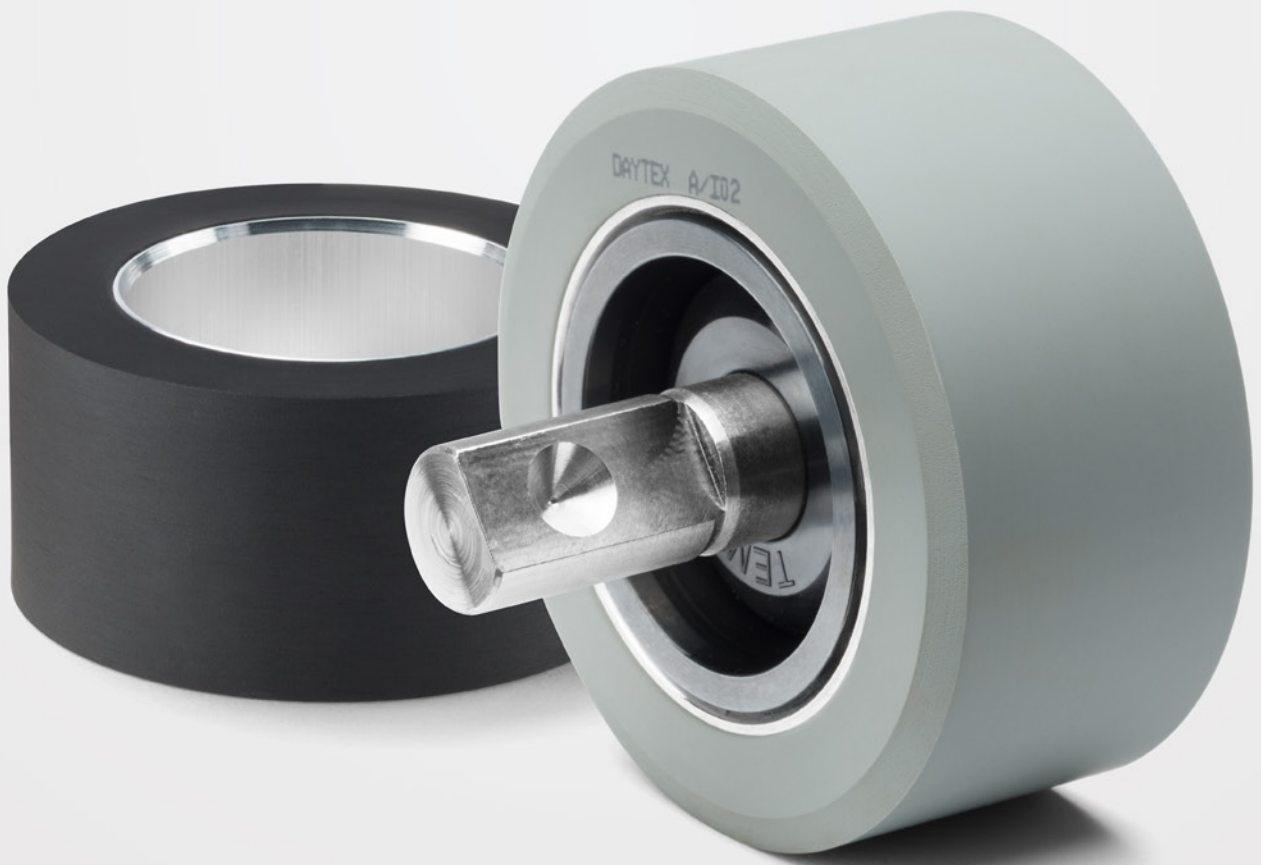

## For Outstanding Yarn Quality

The nip roller unit, consisting of a Temco bearing and a market-standard cot, combines the company's key competencies, which has a direct impact on the quality of the textured yarn.

Modern false twist texturing (DTY) machines are equipped with up to four nip roller feeds per texturing position. Nip rollers have a major impact on the drawing process and therefore exert a direct influence on the quality of the textured yarn. Temco nip rollers also ensure a dramatic reduction of power consumption while maximizing competitiveness.

Nip rollers serve to press continuous material like textile yarn or glass fibers onto a feed shaft during the manufacturing process. This creates frictional locking which guarantees a uniform and gentle drawing of the yarn. The nip roller unit on the DTY machine has a direct influence on the textured yarn quality. This component corresponds to the key competence of Temco: vibration-free running with low bearing friction.



# OUTSTANDING

## ADVANTAGES

Vibration Free Smooth  
Running

Long Lifetime without  
Relubrication

Perfect Operation Based  
on Integrated Vibration  
Absorber and Patented  
Gimbal-Mounting





# Temco Nip Roller LR

Highest Quality  
Standards

Outstanding Product  
Properties

Up to 50% Energy Savings  
Compared to a Conventional  
Nip Roller

Universal Application

# Nip Roller LR

## Expertise

Customers benefit from a huge savings potential on manufacturing costs and by increasing profits. Because nip roller units are synonymous for:

- Up to 50 % energy savings compared to a conventional nip roller
- Outstanding bearing quality for long lifetime without re-lubrication
- Optimal operation performance based on the integrated vibration absorber and patented gimbal-mounting
- Extended unit lifetime

## Product features

- Excellent radial run-out
- Compact construction due to the optimized bearing size
- Low friction moment and thus significant energy savings
- Rotational speeds up to 2 000 m/min
- Maintenance-free due to lifetime lubrication
- Possibility to use different covers
- Gentle yarn treatment



## Advantages

- Outstanding wear and crack resistance, excellent oil, chemical and heat resistance
- Designed to meet the highest demands on all fibers and working conditions for all common and high speed texturing machines
- Long lasting durability and easy handling, ensuring higher productivity
- Better thread clamping force on the yarn, enabled by the higher contact pressure
- Constant pressure against the drive shaft due to lower concavity minimizes light leakage
- Lower vibration level at high production speeds
- Less deformation during regrinding

## Types

Pressfit cots consist of an aluminium core and virtually tension free rubber. This guarantees constant results during the whole life cycle. Springloc cots consist of an elastic core and are used when it is not possible to use pressfit cots because of limited space. For example, like the cots from Accotex DAYTEX:

### **G-836 with 75 Shore A, grey**

The latest cots in the range features technical as well as economical advantages:

- More stable against chemical attacks like swelling
- Less deformation caused by yarn wraps due to the better compression set at process temperatures from 50 to 70°C
- Highest mechanical stability for reduced micro cracking

### **121 - 70 Shore A, black**

- Soft cot for special applications e.g. micro filament and flat yarn
- Highest yarn visibility due to the compound colour

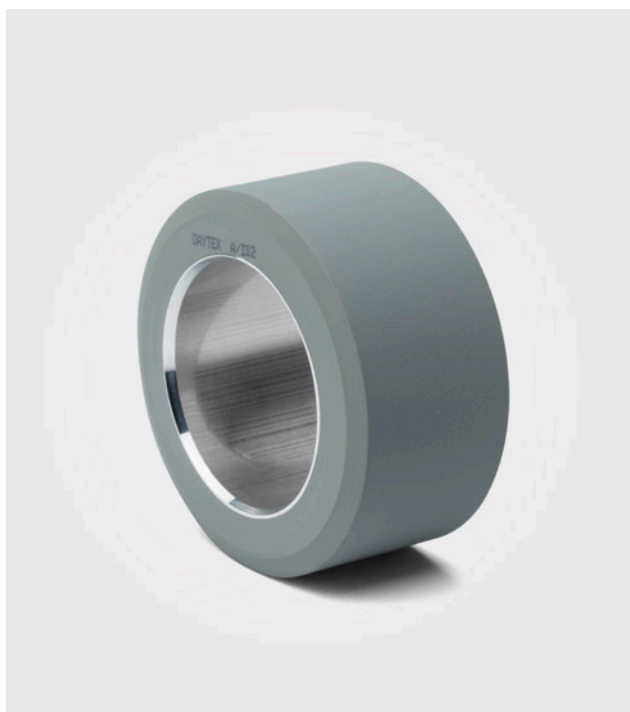

Accotex DAYTEX G-836 with 75 Shore A, grey

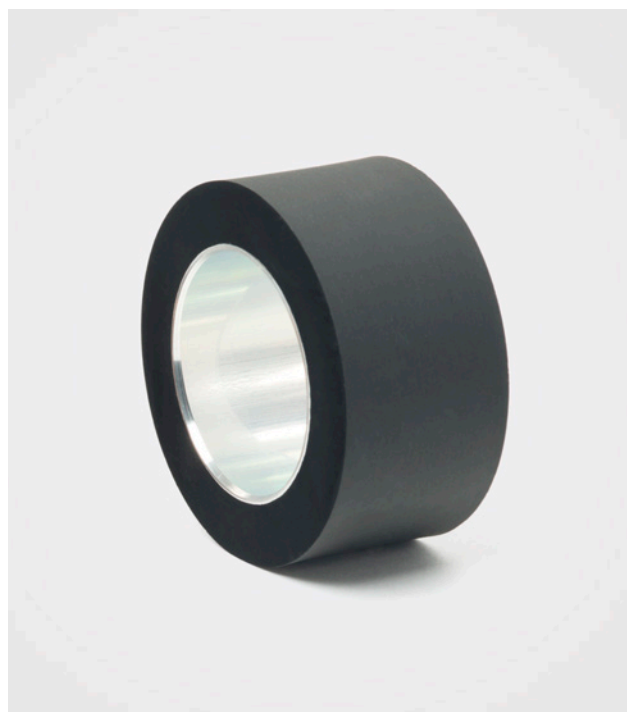

Accotex DAYTEX 121 - 70 Shore A, black

**Temco Nip Roller LR are specified by all the leading texturing machine producers worldwide. The latest polymer technology and state-of-the-art production techniques are the fundamental properties of our manufacturing facility in Germany.**

- High precision and constant tension control at the highest speeds to enable high quality production
- Anti-static elastomer compositions
- Trouble-free running behaviour, less end breaks and thus higher machine efficiency
- Consistency and stability every time
- Outstanding wear and crack resistance, excellent oil, chemical and heat resistance
- Designed to meet the highest demands on all fibres and working conditions for all common and high speed texturing machines
- Long lasting durability and easy handling, ensuring higher productivity
- Better thread clamping force on the yarn. Enabled by the higher contact pressure
- Constant pressure against the drive shaft due to lower concavity minimizes light leakage
- Lower vibration level at high production speeds



# Comparison to the Competition

## Energy saving

Rising energy costs nowadays have a wide influence on your production costs. Temco Nip Roller Units ensure a dramatic reduction of power consumption and maximize your competitiveness.

**Energy LR7035 – power consumption**  
850 m/min – 50N

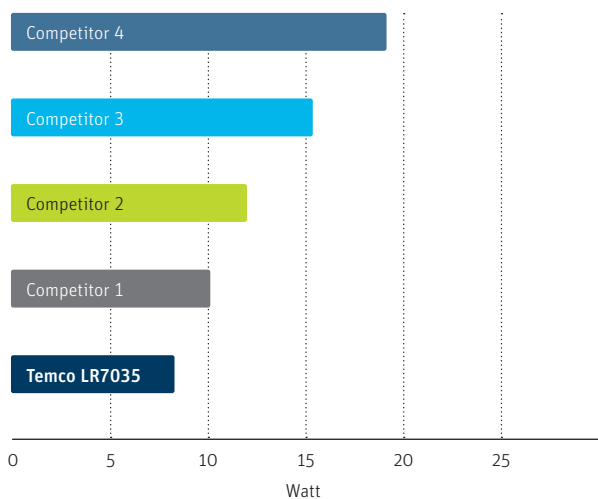

**Cost savings in comparison at 0.1 € per kWh**  
in Euro

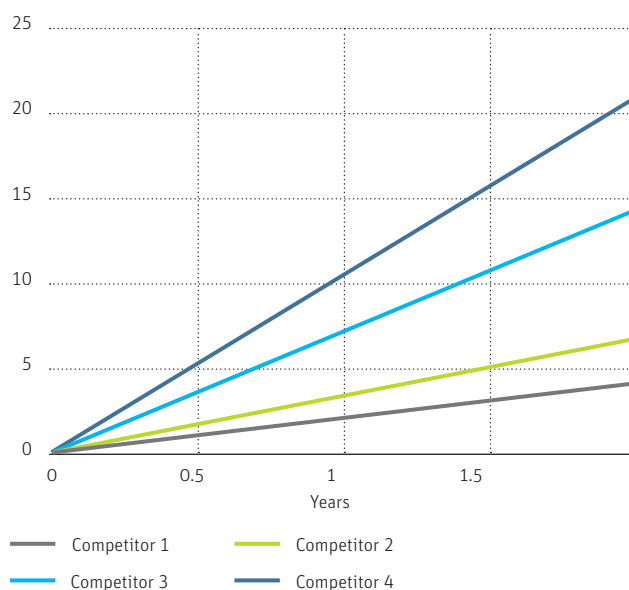

**Assumption**

By switching to Temco, on a DTY machine using 960 Nip Rollers you can save up to 8 400 W. With 8 000 working hours this totals 67 200 kW/yr and it's great for the environment using 51.6 tons less CO<sub>2</sub>.

Power saving = No. of positions  
× no. of nip rollers  
× difference of power consumption in Watt

**Example 1:**

240 pos × 4 nip rollers × 2.625 W\* = 2 520 W

**Example 2:**

240 pos × 4 nip rollers × 8.75 W\* = 8 400 W

\* Power W1 50% of other shafts



# Bearing Assemblies LAG



# Best Results for High Performance Texturing

Wherever texturing units are required to run conductively at the highest speeds, bearing assemblies produce the best results. The Temco bearing assemblies LAG are intended for fitting to friction units for tangential belt or single motor-drive. They are designed to fit all of Temco's texturing units on the market as well as those from other manufacturers.



# OUTSTANDING

## ADVANTAGES

# Bearing Assemblies LAG

Higher Stiffness, Load  
Ratings and Speeds

Maintenance-Free  
Compact Design





Smaller Installation  
Space

Longer  
Service Life



# Bearing Assemblies LAG for Texturing

## Expertise

Temco Bearing Assemblies are designed for installation in friction units for drives with tangential belts or with single motor. However, not only Temco texturing units are equipped with these units. The bearing assemblies are designed in such a way that they can also be installed in all texturing units of other manufacturers known on the market.

The measurement of physical properties is followed by texturing tests with different yarn types. As a result, customers can rely on top yarn quality that is consistent on all machine positions. In addition, the texturing performance is kept constant with different PU lots.





## What to expect

### Product features

- Lifetime lubrication: The Temco Bearing Assemblies are lubricated to cover service life.
- Sealing: Special dust shields on either side protect the bearing assembly against contamination. If required, an additional yarn lap guard can be provided.

### Series ZL

The journal bearings ZL of Temco LAGs are designed to suit various load ratings and maximum admissible speed thanks to different dimensions and bearing designs. Friction discs and yarn guide discs are fitted by slide-fit, while timing belt discs and drive whorls are press-fitted.

The ZL bearing assembly is a unit with integrated bearing i.e. the ball tracks are directly machined into shaft and housing. This design offers compelling advantages: higher rigidity, higher load capacity, higher speeds, longer lifetime, maintenance-free compact design, smaller mounting space required and simple mounting.



# Texturing Discs



# Best Quality Results in the Texturing Process

As a pacesetter in the development of PU texturing discs, Temco continues to set new milestones in texturing disc technology. As a texturing expert, the component manufacturer is in close cooperation with universities and technology leaders in the textile industry.

In-house R&D facilities include texturing machines with various profiles and heater types, as well as a complete textile laboratory. Temco offers the most suitable friction discs with a range of thicknesses and diameters to serve all common texturing units. Different shore hardnesses and shapes can be selected to achieve the best results for customers' specific yarn ranges and processes.

Customer satisfaction is the ultimate goal. Temco's texturing experts provide further advice to customers or carry out trials for customer-specific applications in the company's own textile laboratory.

PU discs from Temco offer the advantage of much less abrasion on the yarn surface compared to ceramic discs. This leads to better strength and elongation, resulting in fewer filament and yarn breaks and minor machine contamination. The highest accuracy in terms of dimensions as well as material composition guarantees equal yarn values from the first to the last position of the machine, year after year, from lot to lot!



# OUTSTANDING

## ADVANTAGES

# Texturing Discs

Optimization of Yarn  
Path Geometry

Highest Qualities  
even at High  
Texturing  
Speeds

Lateral  
Grinding  
for Higher  
Precision



More Stable  
Yarn Quality

Improved Heat  
Transfer Due to  
Optimized Air Flow



Compliance with  
Tight Tolerances  
During Production

# PU Discs for Texturing Processes

## Expertise

PU discs are softer than the yarn, handle the yarn with care during twist insertion. The best yarn quality is based on careful selection of PU material, disc geometry and surface structure. Numerous tests with strict limits keep the texturing performance of Temco discs within narrow limits.

The measurement of physical properties is followed by texturing tests with different yarn types. As a result, customers can rely on top yarn quality that is consistent on all machine positions. In addition, the texturing performance is kept constant with different PU lots.

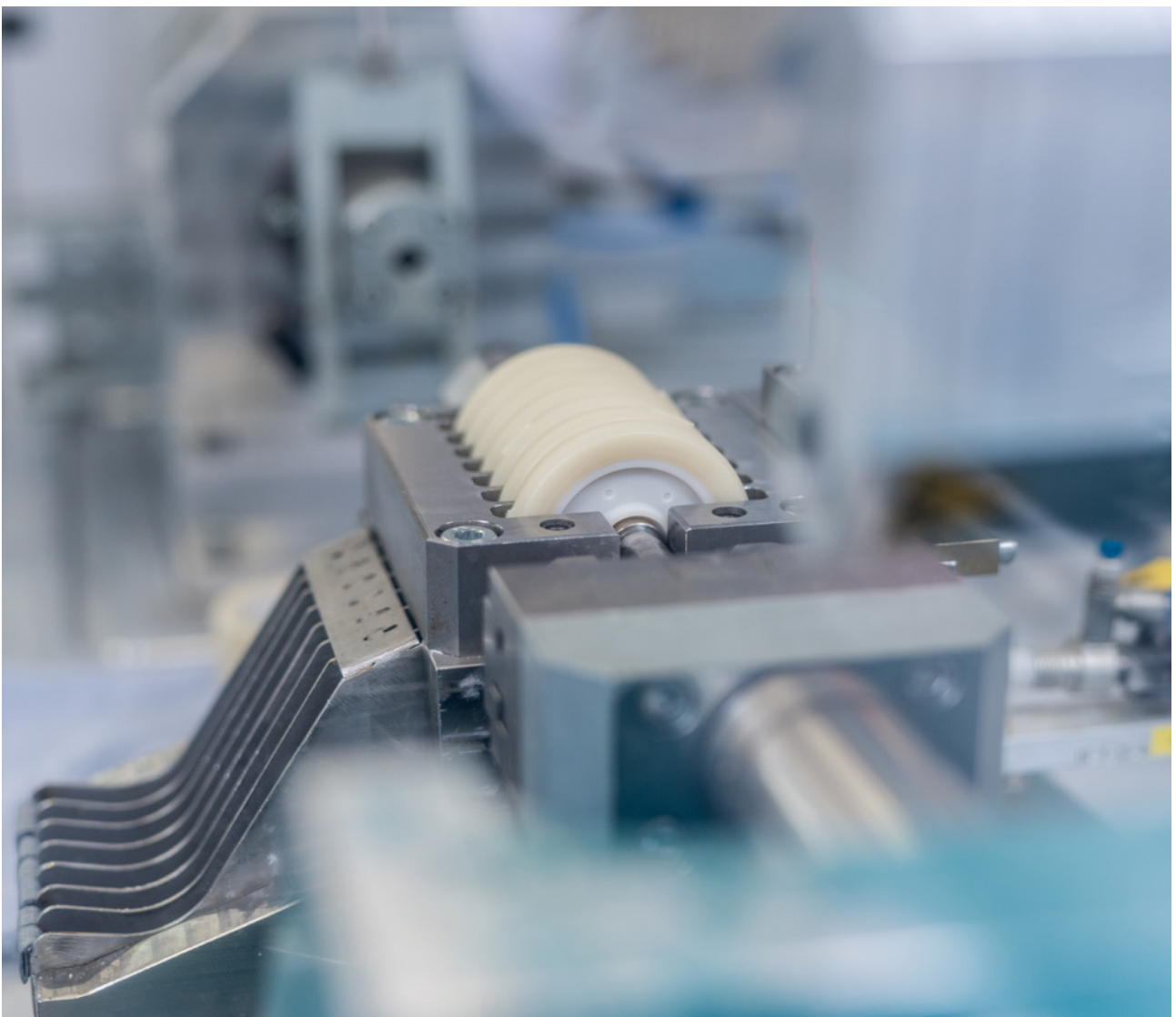





## What to expect

### Area of application

In texturing, friction discs are the key component for successful and profitable yarn production. By developing PU material, optimizing yarn path geometry and maintaining tight tolerances in manufacturing and quality control, Temco has set world standards with its texturing discs.

This enables the highest quality demands on textured yarns to be met at high texturing speeds:

- Twist level and stability
- Yarn tensile performance
- Yarn bulk and elasticity
- Low process and machine CV

### Customer Benefits

The depth of experience gained in this process has enabled us to meet the ever increasing demands in:

- Yarn quality
- Production speed
- Process flexibility
- Process economics

# CoolFlow Texturing Disc

## The next generation

The long-term experience in disc manufacturing, filament processing and ongoing research and development are the origin of the latest development.

The German Institute for Textile and Fiber Research has carried out simulations of the texturing process and demonstrated that the air flow between the discs has been optimized. The improved heat transfer has been confirmed in numerous field tests around the world.

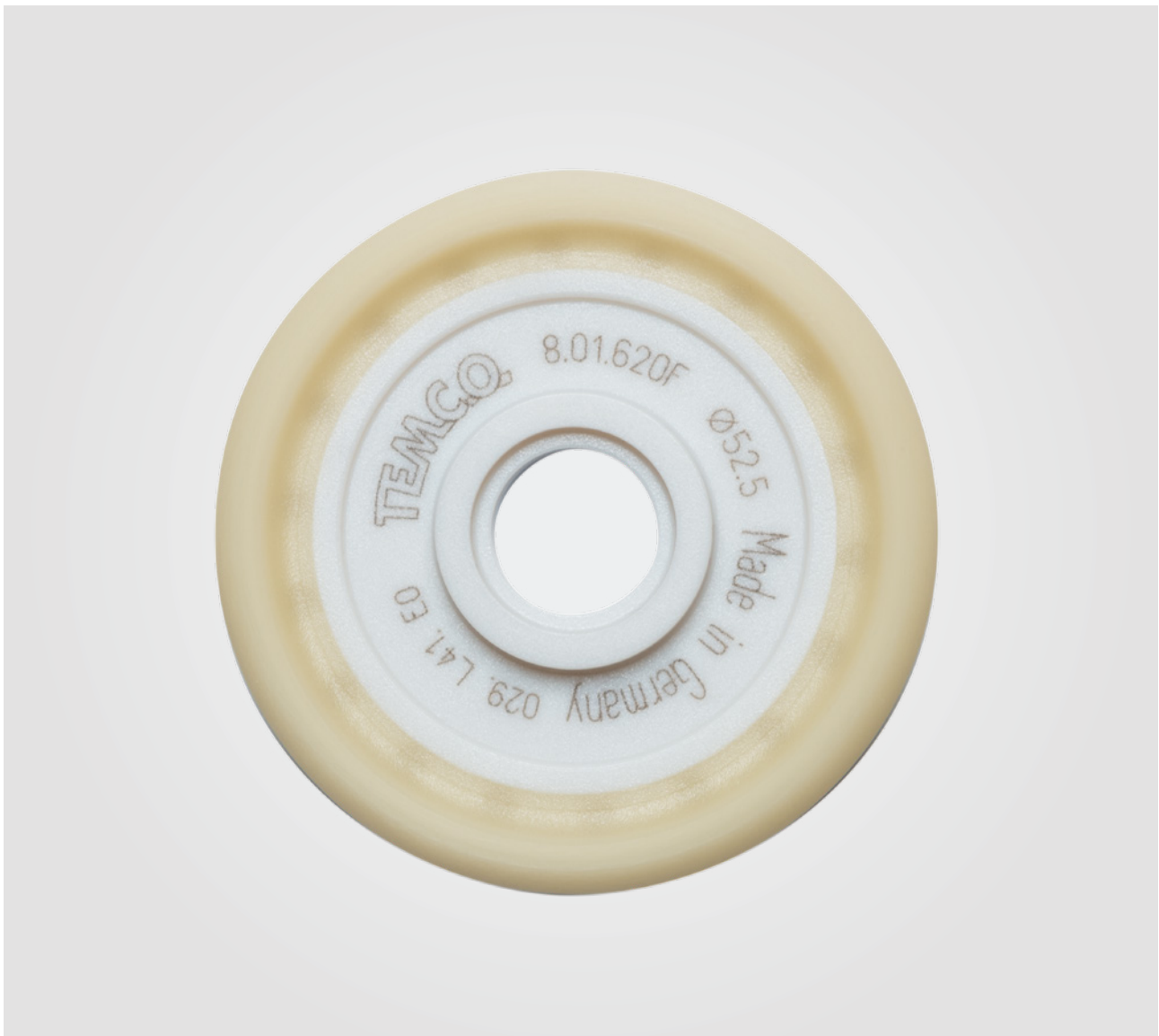



## Features and benefits

The new geometric structure of the Temco texturing discs results in improved heat transfer efficiency, which in turn results in lower disc temperatures, longer product life cycles and process cost reduction.

The CoolFlow disc has a direct influence on the yarn quality as well as on process parameters and ensures:

- More stable yarn quality
- Higher dyeing uniformity
- More physically stable yarn characteristics
- Higher positional stability
- Increased yarn tension stability
- Lower machine CV value result

# Temco GreenDisc

## Sustainability in the texturing process

In texturing, discs are the key components for successful and profitable yarn production. By developing PU material, optimizing yarn path geometry and maintaining tight tolerances in manufacturing and quality control, the new GreenDisc adds sustainability as a feature.

Temco's sophisticated design and valuable market experience gives the GreenDisc a unique quality. While maintaining process stability and product quality, Temco's GreenDisc makes a significant contribution to sustainability in the textile industry.



# GreenDisc – New Era of Texturing Discs

## Customer benefits

- Less handling and storage costs
- Less trash taxes
- Shorter delivery times
- Through Temco products, customers contributes to more sustainable yarn production
- Unique product in the global textile market
- Sustainability concept
- 100 % quality control
- Grinding process well established
- Automation improves error rate
- Stock building at Logistic-Centers
- Stable quality
- Sustainable disposal
- Quality “Made in Germany”

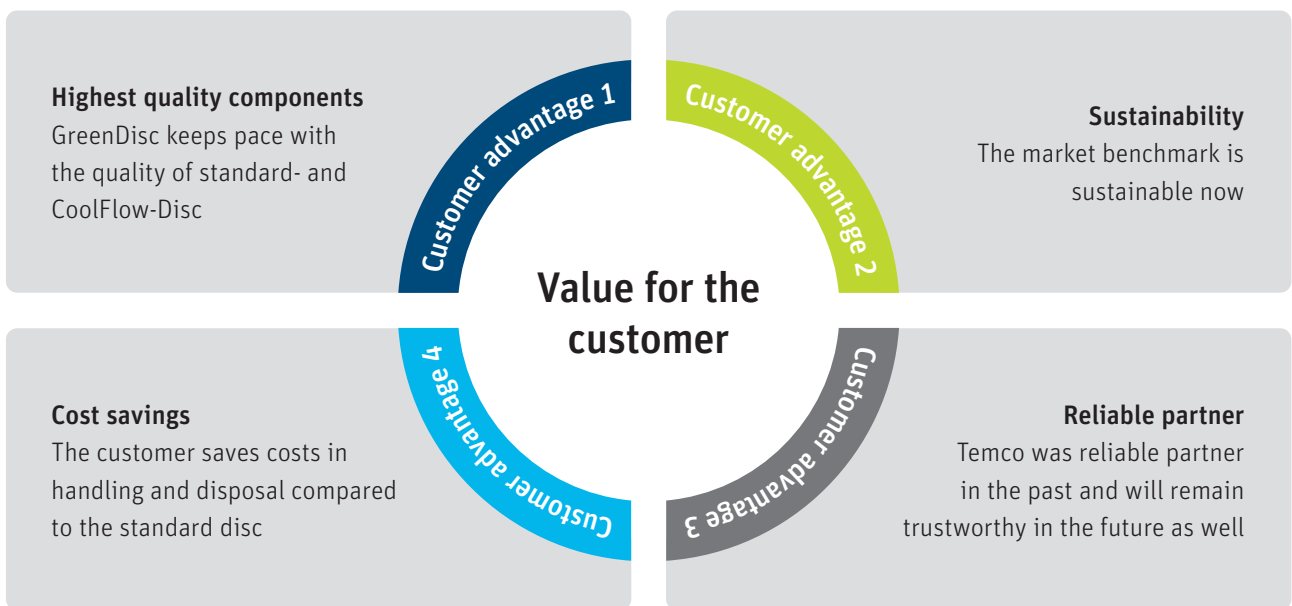

Customer value proposition

# GreenDisc

## OUTSTANDING

## ADVANTAGES

Optimum Yarn  
Path Geometry

Market-Leading  
Quality

Highest Quality at  
Maximum Texturing  
Speeds





Only Sustainable  
Texturing Disc Worldwide

Monetary  
Cost Benefits

Best Product Properties  
Combined with  
Sustainability and Effort  
Savings

# The Benchmark – Now Sustainable

## Technical Expertise

- Time-tested quality of the Temco PU disc
- Carrier and PU ring can be separated (3 individual parts)
- Carrier material is recycled and reintroduced into the process
- PU ring is disposed of sustainably
- Disc is now separable from the carrier
- Stable texturing process
- Yarn quality remains constantly at the highest level

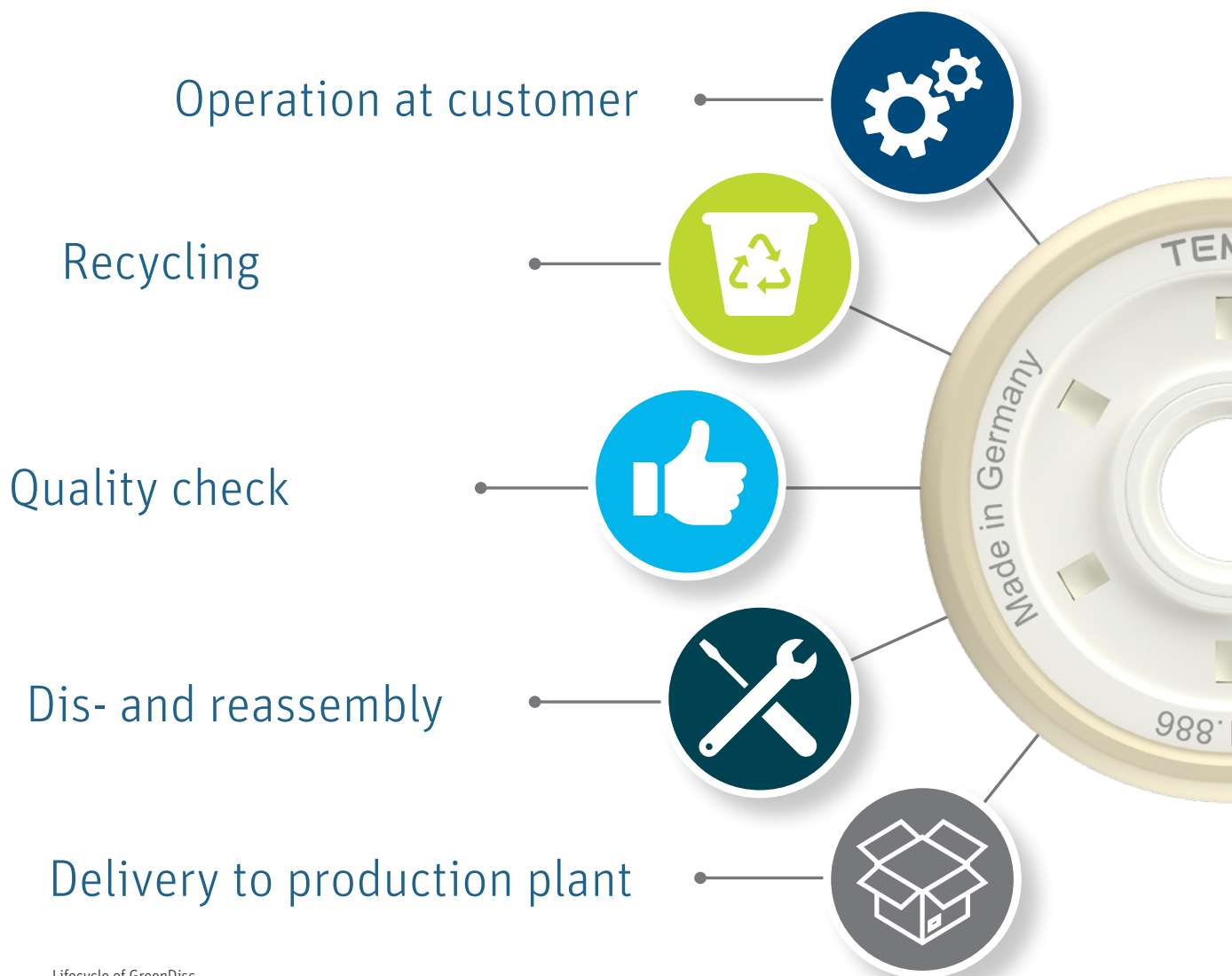

Lifecycle of GreenDisc



## Product USP's

- Twist level and stability
- Yarn tensile performance
- Yarn bulk and elasticity
- Low process and machine CV
- Lateral grinding for higher precision
- Compliance with tight tolerances during production
- Highest quality of textured yarns at high texturing speeds

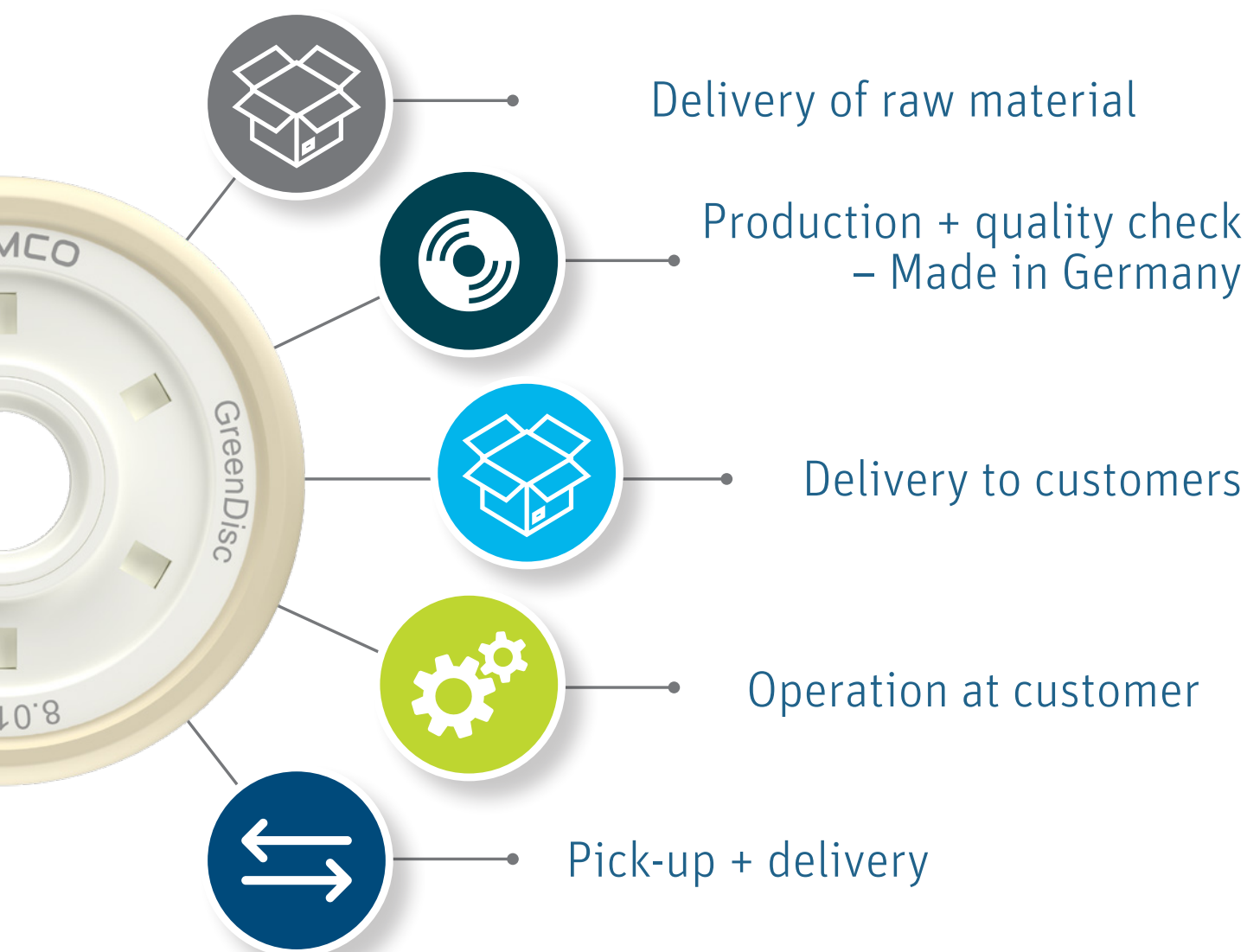

## Product figure GreenDiscs

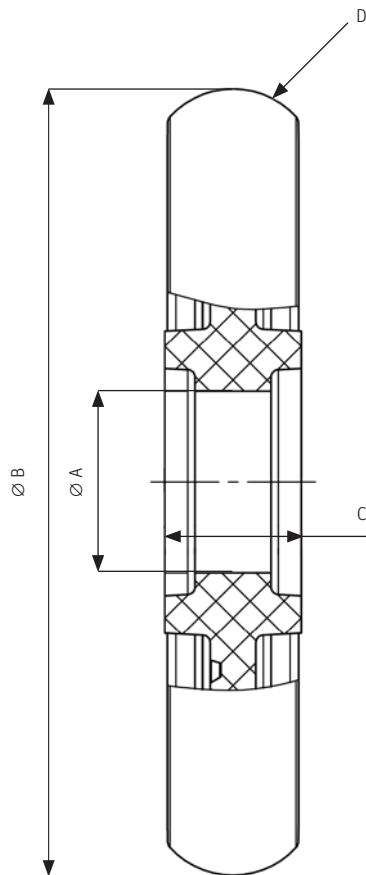

## Product overview GreenDisc

Product	Profile application D <sup>1</sup>	Material hardness <sup>2</sup>	Width C [mm]	Outer diameter Ø B [mm]	Bore diameter Ø A [mm]	Type
8.01.886F	C	F	9	52.0	12.0	GreenDisc
8.01.896F	C	F	9	52.5	12.0	GreenDisc

<sup>1</sup>Type of profile:

C = high bulk, D = high speed

<sup>2</sup>Type of material:

F = 86 Shore A





# Texturing Unit FTS

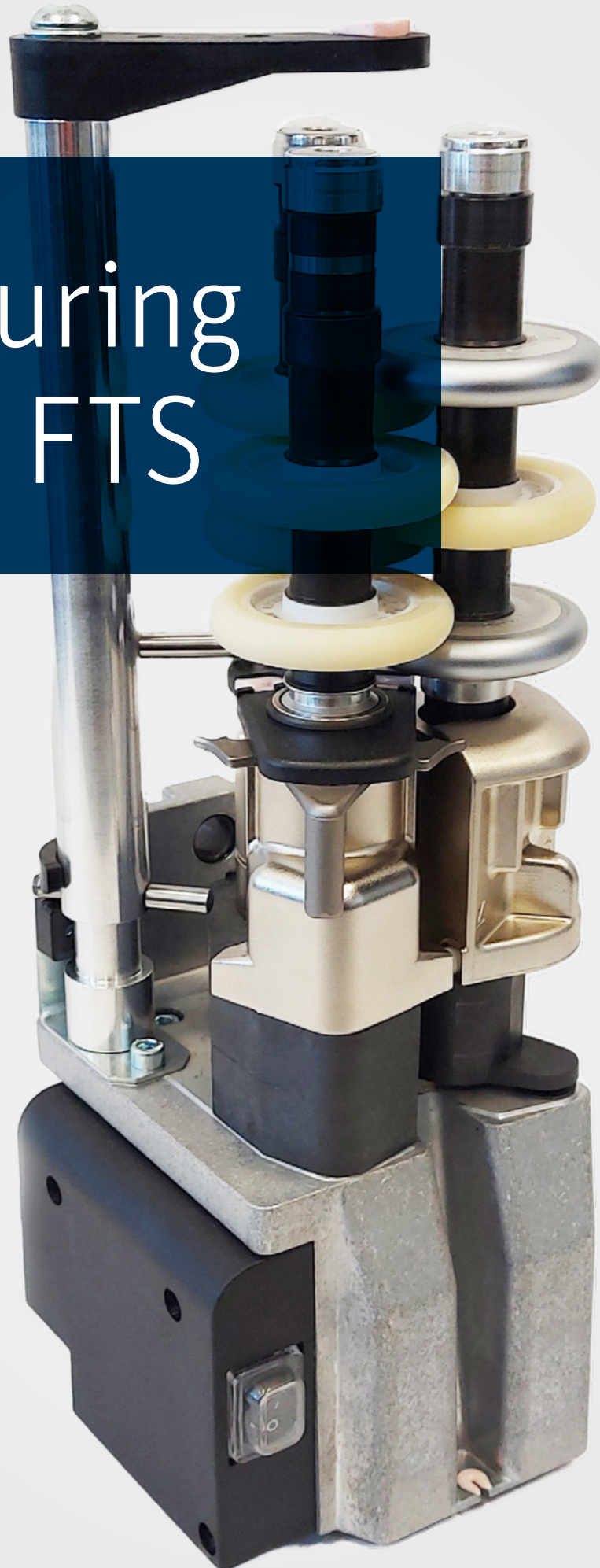

# Leading in Precision, Productivity and Quality

Temco Texturing Units are leaders in precision, productivity and yarn quality. The long lifetime and fast speeds together outperform the many competitors on the market.

Customers get a high value product that features the latest technology. The unique design of the Temco open/close unit in particular increases the efficiency of the texturing machine.

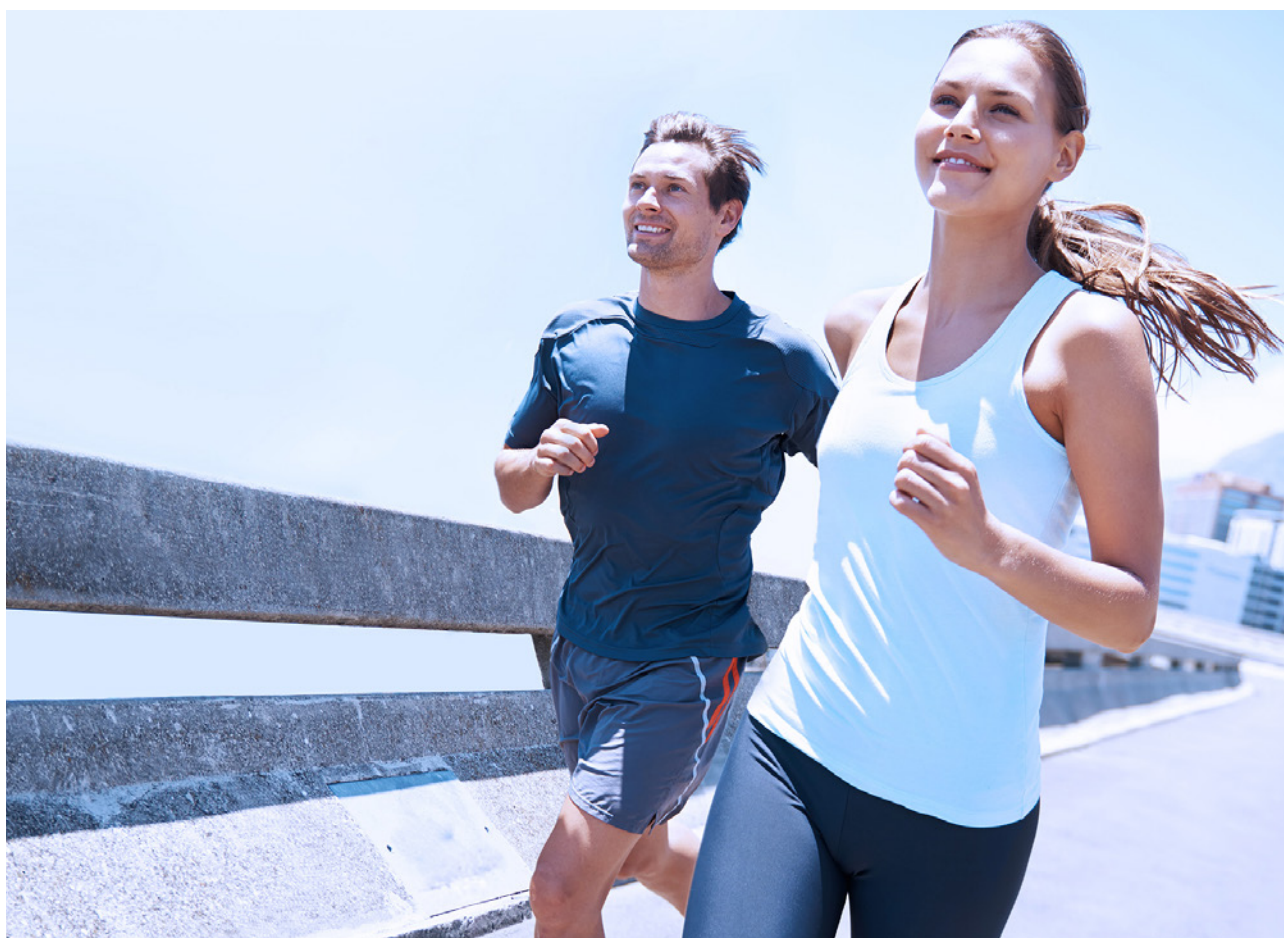

# OUTSTANDING

## ADVANTAGES

# Texturing Units FTS

Open/Close System

Low Vibration at High  
Yarn Take-off Speeds

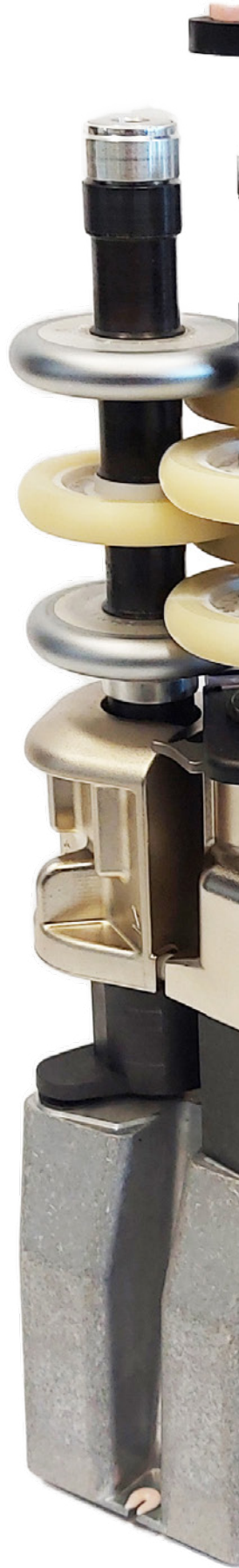

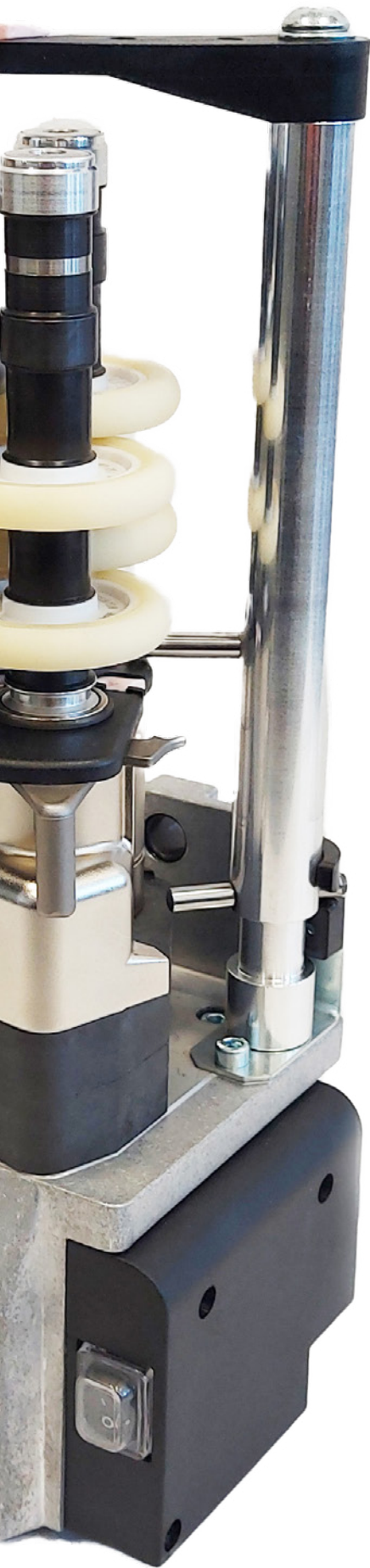

Simple and Fast Changeover  
of S/Z Yarn Twist Directions

Highest Process Speeds

# Texturing Unit FTS525M Open/Close

## Expertise

The Temco FTS525M is a motor-driven single unit. Due to its pivoting open/close mechanism and the integrated threading device, even critical yarns can be threaded safely and quickly even at the highest process speeds. Yarn tension peaks are significantly lower when threading as opposed to a fixed center unit, resulting in significantly reduced numbers of yarn breaks during threading.

Another significant advantage of this unit series is the simple and fast changeover of S/Z yarn twist directions. Dismantling of the discs and their spacers is not necessary for this changeover.

Unit head and motor are in line and connected by means of a coupling without intermediate drive. The bearing shaft diameters of 14.45 mm are highly rigid.

Together with additional damping, this guarantees low vibrations even at high yarn take-off speeds. The careful design ensures an exact fit of the integrated, high-speed bearings and friction discs, which is a prerequisite for high yarn evenness on the machine.

The texturing discs are attached to the LAG bearing shaft via a slide fit and are secured with a spring cap with a defined pressure force. This construction, together with the open design of the units, enables a rapid disc change.

The cover of the toothed belts prevents contamination and ensures a long belt-life.



Texturing unit open



## Open/close system

The design of the open/close unit in particular increases texturing machine efficiencies. The possibility to open the unit significantly reduces adverse effects on yarn tension during threading and the possibility of resulting yarn breaks are minimised, even for low count microfilament yarns.

Threading process at the open/close unit  
Using the incorporated threading mechanism, the yarn is threaded into the centre of the unit without excessive tension.

As highlighted in the comparison, yarn tension peaks are significantly lower when closing the unit compared to a fix centre unit.

For microfilament yarns in particular, this gentle method of threading results in significantly lower yarn breaks at positional start-up and consequently a marked reduction in time to thread the entire machine. Moreover, during the process, there is no threading gate, which restricts handling or vision of the yarn path in the open/close unit.



Texturing unit closed



Threading process at an open/close unit

- 1 The yarn is positioned for the threading process.
- 2 Using threading tines of a gate system, the yarn must be pressed across the area where the disc overlap is highest. Here, the tension peaks are at their highest, leading to a possibility of yarn breaks:

a) The yarn is in a vertical position to the disc profile and is not influenced by force components from the rotating disc but is transported inwardly.

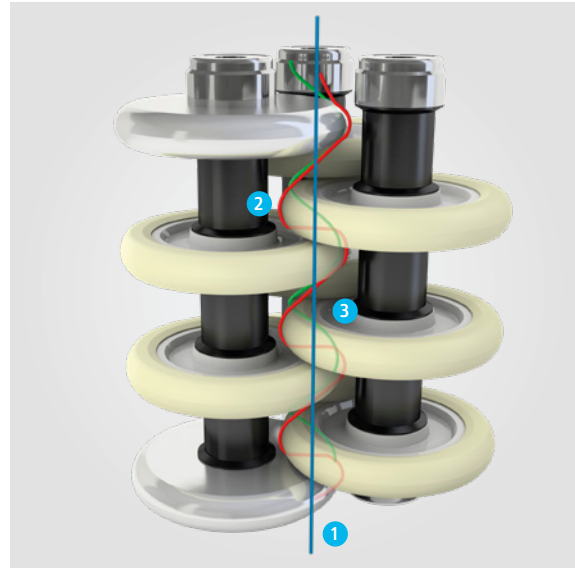

Threading process at a fix center unit, side view

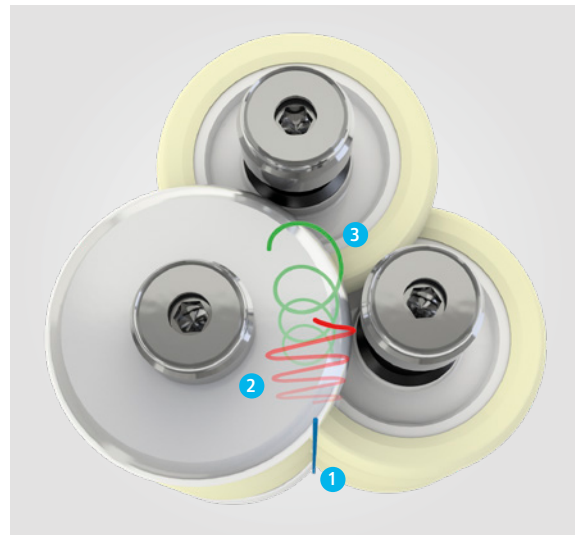

Threading process at a fix center unit, top view

- b) The yarn is unstable within the threading area between 1 and 2 due to conflict in yarn transport directions between the left hand and right hand disc stacks.
- 3 The yarn is stable in the texturing unit center.

# Technical Characteristics

## Specifications

- Disc diameter 52 up to 53.5 mm
- Disc thickness 9 mm
- Max. disc combination 1-8-1
- Shaft diameter 14.45 mm
- Minimum pitch 110 mm
- Yarn entry and exit guides: snap-in
- Axial distance 37 mm
- Diabolo spacers
- Fitting caps with defined pressure force
- Drive (to the motor): coupling

## Comparison fix center unit with open/close unit

Yarn tension variation with fix center unit  
in cN

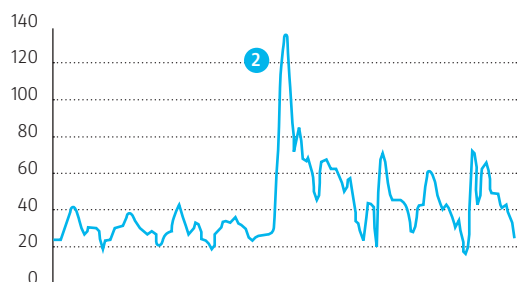

Yarn tension variation with open/close unit  
in cN

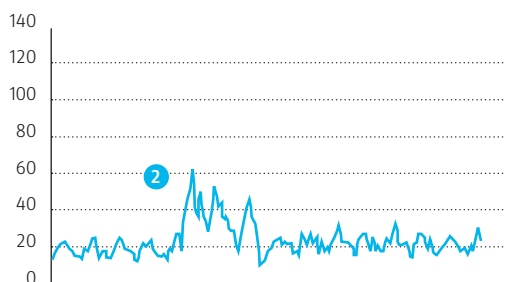

## Yarn running speeds compared to the disc circumferential speeds

Yarn running speeds compared to the disc circumferential speeds  
in D/Y

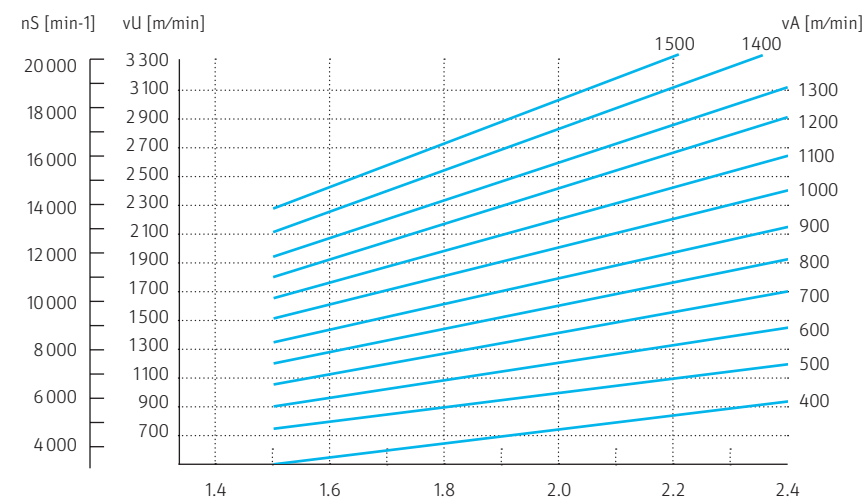

Yarn running speeds VA [m/min] and disc speeds ns [min-1] in dependence on D/Y:

Friction discs 52 mm diameter  
vU = Disc circumferential speeds [m/min]

vA = Thread delivery speeds [m/min]  
nS = Disc speeds [min-1]



# Air Interlacing Jets LD



# Highly Productive

With the undeniable advantages of their Air jets in quality and economic efficiency, Temco components have reached a leading position in this market segment.

The products are manufactured and subjected to quality controls in accordance with the most modern methods, thus ensuring a continuous high quality standard.

This requirement is of paramount importance, especial methods, thus ensuring a continuous high quality standard especially for products used in large numbers in processing plants.

Temco develops innovative solutions such as highly productive interlacing jets for carpet yarns (BCF), single or folded yarns as well as textile or technical applications.



# OUTSTANDING

## ADVANTAGES

# Air Interlacing Jets LD

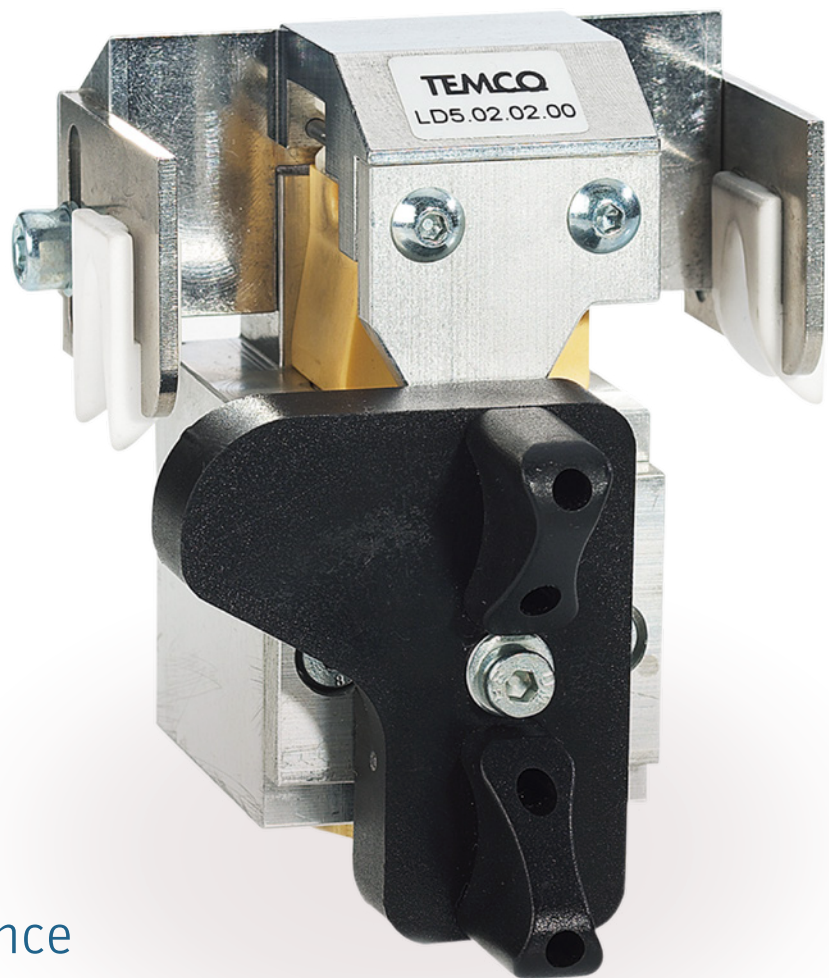

High Positional  
Uniformity

Optimum  
Performance



High Process  
Security

Flexible  
Solutions

# Interlacing Jets LD32/LD4/LD5

The appropriate jet solution for every process

For the benefit of customers all over the world, a creative team of engineers has been developing air interlacing jets for all textile processes and various applications since 20 years now, in a prosperous co-operation with the university of Stuttgart (ITV, Denkendorf), which provides an increase of productivity as well as yarn quality.



## LD32 1

The LD32 is the flexible single- or multifilament solution for all machines. The unique, pneumatically controlled open/close design ensures high process security. The LD32 jet can interface with your machine control, resulting in optimised jet handling.

## LD4 2

The LD4 is a further design development of the LD32 jet where even higher speeds are realised due to the tandem arrangement of the jet.

## LD5 3

A special application area for the LD5 is the package winding process for textile BCF yarns. Moreover, it is also suitable for technical single-, combined- and effect yarns.

## Technology

The jet inserts provided are designed in a way that they generate the optimum performance for each yarn type. The interlacing properties for each yarn can be adapted through interchangeable ceramic inserts.

The jet body is the basic component that supports the different, available jet inserts for single- or multifilament yarns. Findings from research and development continuously enrich the optimisation process of the product portfolio.

## Quality

The jets are manufactured and subjected to quality control using the most modern methods, thus ensuring a continuous high quality standard. This is of paramount importance, especially for positional uniformity.



## Area of application

The complete LD series with the LD32, LD4 and LD5 are suitable for the illustrated processes:

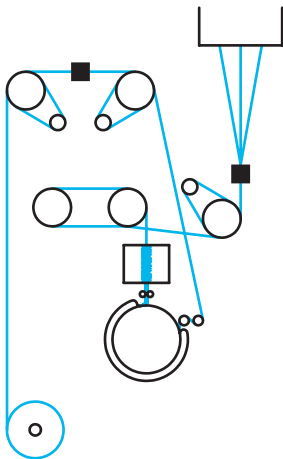

BCF-spin-draw-texturing

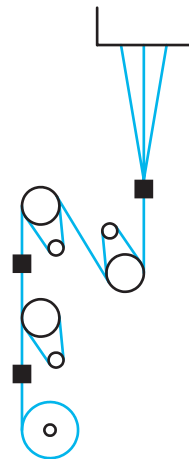

SDY/FDY/CF

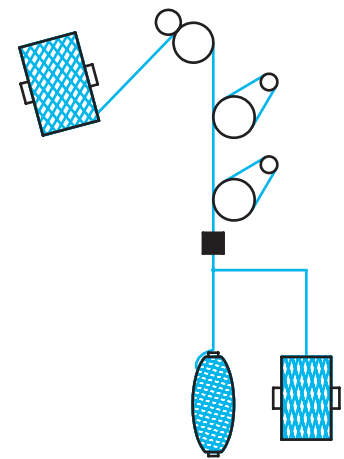

Draw twisting/winding

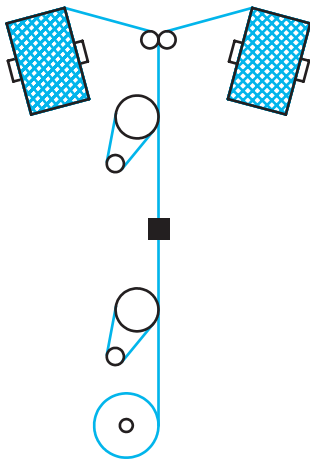

Plying

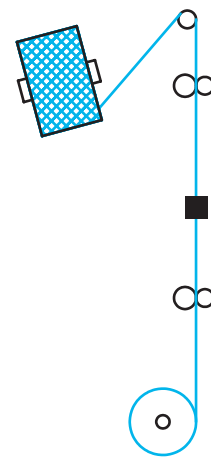

BCF-winding

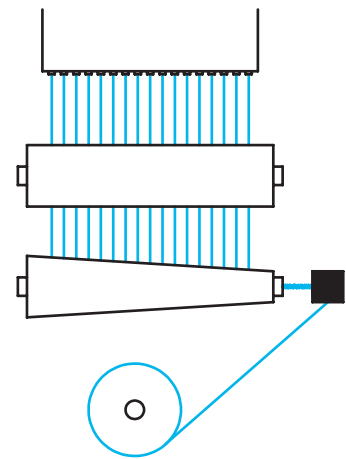

Glass-fiber-spinning

# Interlacing Jets LD32

Tangling jet for BCF yarns and technical yarns

The LD32 interlacing jet in a modular design complying with the requirements for ever increasing process speeds for technical yarns, e.g. glass and carbon fibers and carpet yarns. The single or multiple thread line LD32 fits on all spin draw texturing machines known on the market for new installations or retrofit.

Thread speeds of up to 4 000 m/min

The Temco LD32 interlacing jet is available in modular design to meet the requirements for ever higher yarn speeds when processing industrial yarns, e.g. fiberglass and carpet yarns.

The LD32 fits on all spindraw texturing machines known on the market for initial equipment or upgrading. These jets are suitable to process yarns up to dtex 10 000 at thread speeds of up to 4 000 m/min depending on the relevant titer.

A suitable material allows a good reproduction of geometry, shape and surface of air and thread ducts, and ensures a high uniformity.

The interchangeable ceramic inserts offer the possibility to achieve hard, soft, short or long knots according to the desired interlacing.

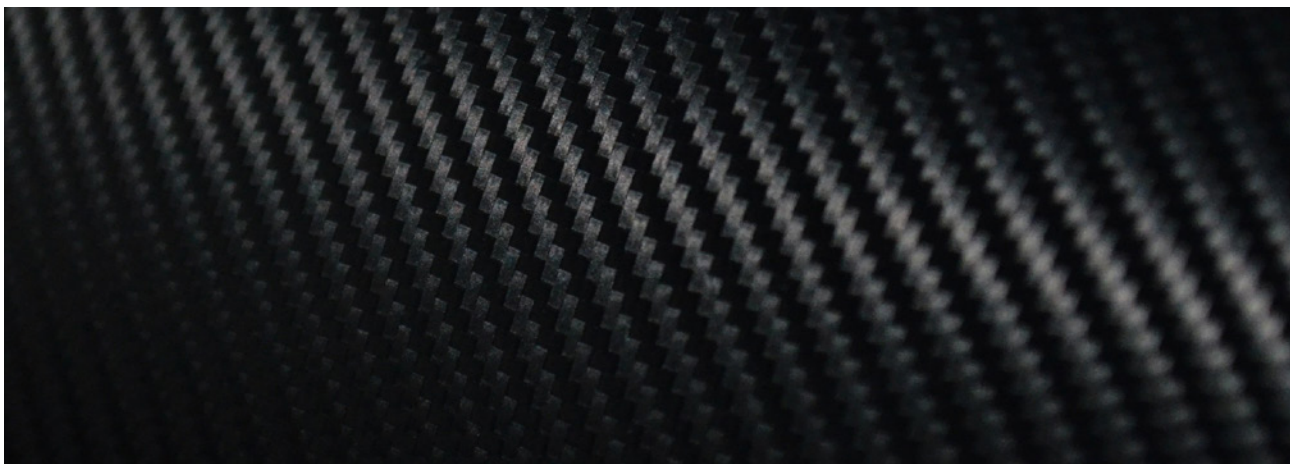

## Product properties

- Function: tangling jet
- Design: open-/close (automatically)
- No. of threads: 1, 2, 3, 4, 6
- Yarns: BCF yarns and technical yarns (PA, PES, PP ...)
- Titer range: up to 10 000 dtex

## Features and benefits

- Jet inserts made of high grade ceramics
- Designed with optimized blast and thread duct cross sections which help to
  - reduce air consumption
  - attenuate noise emissions
  - obtain better textile processing
  - handle yarns more smoothly
  - increase the service life.
  - High product uniformity construction
- Due to a suitable material which allows a good reproduction of geometry, shape and surface of air and thread ducts.
- Interchangeable ceramic inserts to set either hard, soft, short or long knots in line with the requested interlacing.

## Product advantages

- Automatic stop of air-flow for less air consumption
- Automatic open/close for safe threading
- Long service life (ceramic inserts)
- Modular design (interchangeable inserts)
- Adjustable yarn guides for flat or textured yarns



# Interlacing Jets LD4

Air jet for tangling applications

The Temco LD4, which incorporates the job-proven engineering and technology of the LD32 jet, has been especially designed for the high-duty BCF and installations for other industrial yarns.

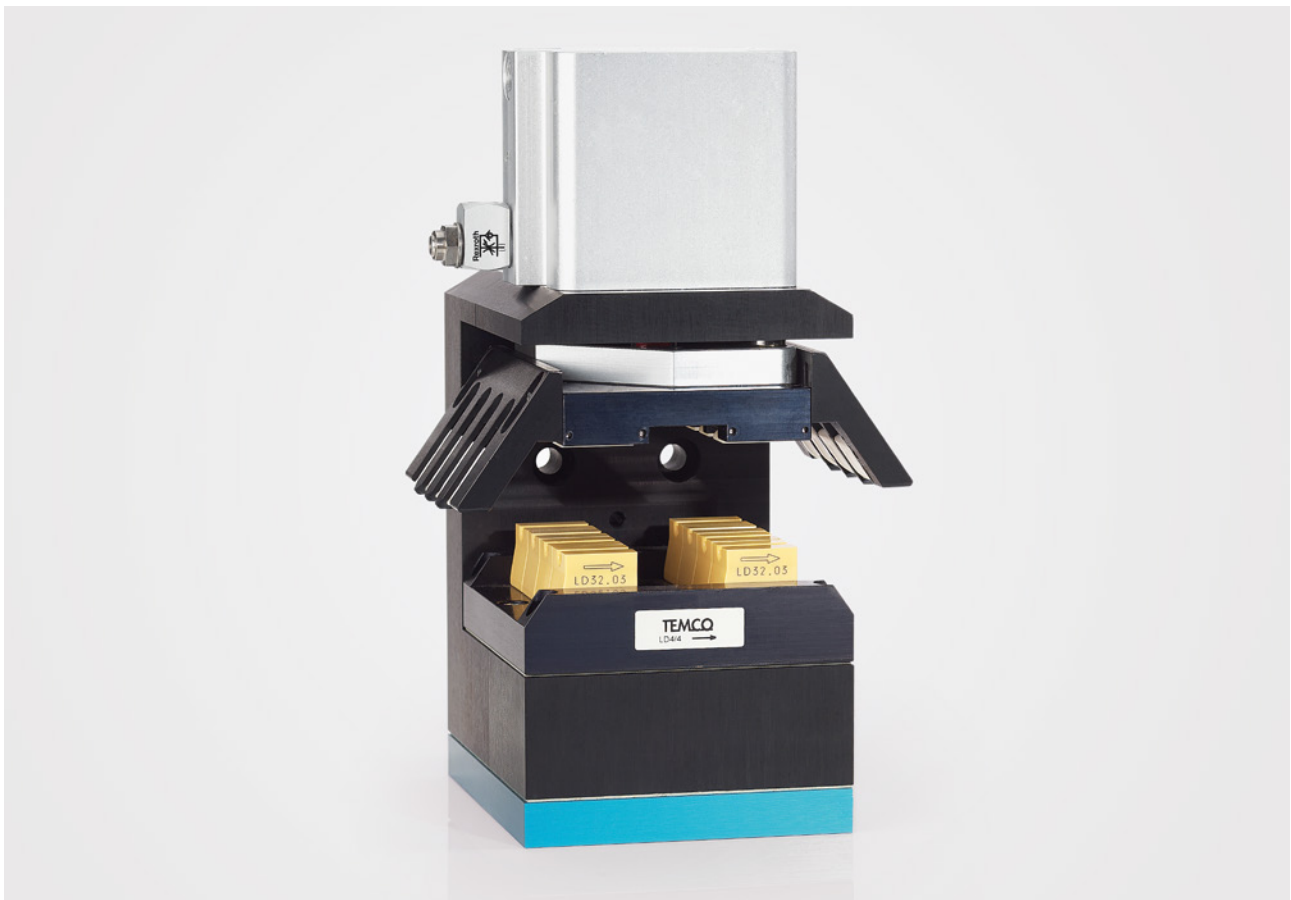

## Highest yarn speeds

With the tandem arrangement on the LD4, it is possible to optimize the tangling effect even at the highest yarn speeds. The LD4, which incorporates the proven engineering and technology of the LD32, was developed specifically for the new high-performance BCF lines, but can also be used on other machines, for CF, POY, FDY and HOY yarn processes.

Depending on yarn, titer and felting quality requirements, yarn speeds of up to 7 000 m/min can be achieved: This results in a further increase of about 50% compared to the LD32, which benefits from the mechanical speeds of the new BCF equipment. With a payback period of just under 6 months, the LD4 offer a highly interesting, cost-effective investment.

## Product properties

- Function: tangling jet
- Design: open/close (automatically), tandem
- No. of threads: 1, 2, 3, 4
- Yarns: BCF and technical yarns (PA, PES, PP ...)
- Titer range: up to 10 000 dtex

## Product advantages

- High speeds up to 7 000 m/min
- Automatic stop of air-flow for safe threading and less air consumption, in connection with the machine control
- Long service life (ceramic inserts)
- Modular design (interchangeable inserts)
- Adjustable yarn guides for flat or textured yarns

## Features and benefits

- Production increase by 50%
- Yarn speeds up to 7 000 m/min can be achieved depending on the yarn, titre and requirements placed on the interlacing quality. Previous system allowed half of the production speed for standard titres.
- Low air consumption
- Very good interlacing quality
- Patented tandem layout For an optimal interlacing effect, even at the highest yarn speeds.
- Interchangeable ceramic inserts (depending on titre)
- Long service life
- Characterised by high knot-number and uniformity



# Tangling Jets LD5

Tangling/commingling jet for BCF and industrial yarns

**Temco has designed the tangling jet LD5 incorporating the job-proven engineering and technology of air jet LD32 to meet the market requirements.**

## For glass fibers and more

The Tangling jet LD5 is meant to operate on winders as well as on air tangling installations and spinning machines. It is used for interlacing flat and textured yarns.

Special application fields cover winders for BCF yarns, for textile areas for instance in carpets, extending also to single, multiple and blended yarns for industrial applications: Titters up to dtex 10 000. A further interesting usage for the LD5 is the manufacture for instance of inorganic materials such as glass fibers.

There are various jet inserts available with different air ducts to suit the yarns and titters in processing. The insert itself is made of high-resistant ceramics.



## Product properties

- Function: tangling jet
- Design: open/close (automatically), tandem
- No. of threads: 1, 2, 3, 4
- Yarns: BCF and technical yarns (PA, PES, PP ...)
- Titer range: up to 10 000 dtex



## Product advantages

- High speeds up to 7 000 m/min
- Automatic stop of air-flow for safe threading and less air consumption, in connection with the machine control
- Long service life (ceramic inserts)
- Modular design (interchangeable inserts)
- Adjustable yarn guides for flat or textured yarns



## Features and benefits

- Production increase by 50 %
- Yarn speeds up to 7 000 m/min can be achieved depending on the yarn, titer and requirements placed on the interlacing quality. Previous system allowed half of the production speed for standard titers.
- Low air consumption
- Very good interlacing quality
- Characterised by high knot-number and uniformity
- Patented tandem layout
- For an optimal interlacing effect, even at the highest yarn speeds
- Interchangeable ceramic inserts
- Long service life



# i-Bearing Wireless





# Self-Powered, Intelligent, Wireless

## i-Bearing – the wireless monitoring system

In the future, IIOT Systems (Industrial Internet of Things) such as smart factories or proactive device monitoring will be the key to success and cost management. Temco provides a proactive equipment monitoring system for various ball bearing arrangements from its product portfolio. The intelligence of the i-Bearing allows the constant condition monitoring of every single bearing within the plant. The patent pending i-Bearing works without cable – the sensors and electronic devices are integrated into the bearing without significant changes to the external dimensions.

Temco's i-Bearing intelligent solution for filament machines enables, among other things, the recording and analysis of data with a timely response to malfunctions in the bearing through online condition monitoring. Through predictive maintenance, process control and process tracking, bearings can be replaced before they fail. This helps to minimize machine downtime. The user can extract other parameters from these measured values and calculate them for his or her specific application. For example, it is possible to determine the process speed from the bearing speed (rotational speed).



# OUTSTANDING

## ADVANTAGES

Self-Powered

Higher Efficiency of Production  
& Improved Machine Availability

Ability to Track  
and Analyze Data

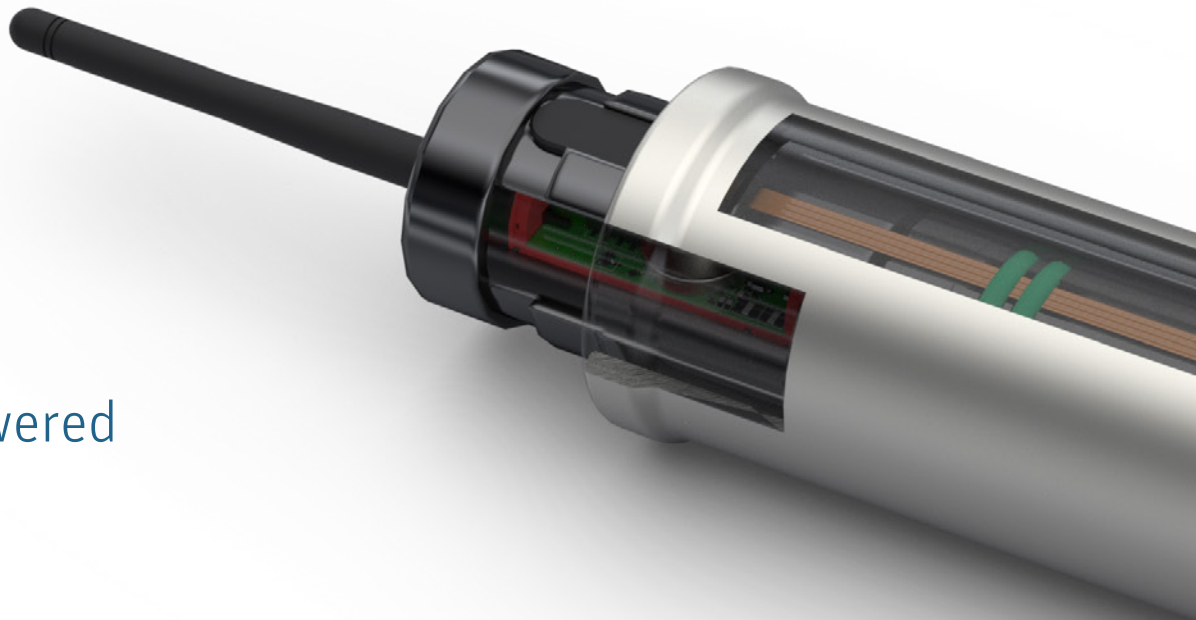

# i-Bearing Wireless

Real Time-Monitoring  
of All Bearings

Measurement  
of Vibration,  
Temperature and  
Rotation the Bearing

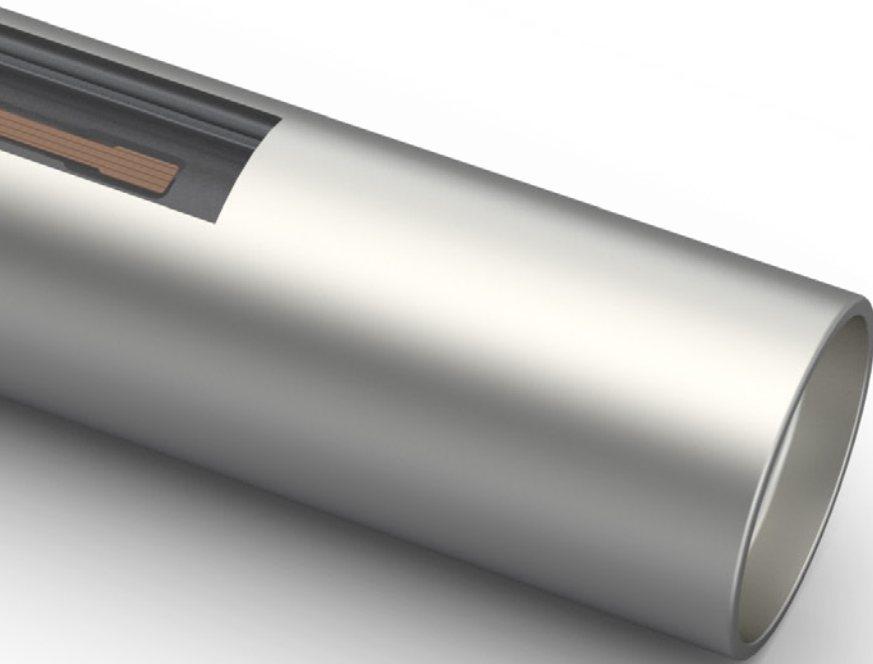

Wireless

Process Stability

# Wireless Condition Monitoring

The i-Bearing monitoring system consists of a bearing with sensors and power supply integrated directly into the bearing. Customers benefit from a clear understanding about the status of their bearings. In the future, items with potential defects will be identified immediately, allowing replacement before a malfunction or more serious problem occurs. Thanks to this timely insight, customers can plan machine maintenance and associated downtime in advance and align it with the most efficient maintenance schedule.

## Key performance factors

- Detection of bearing damage by comparing measured values with set limits
- Vibration, temperature and rotation measurement of the bearing
- Recording of the measured values in a diagram
- Simple and clear installation without wiring on the machine
- Bearing replacement before a malfunction or a more serious problem
- Higher efficiency of production & improved machine availability
- Reduction of overall operational costs
- Continuous improvement of operation & equipment
- Online monitoring of parameters at regular intervals through powerful visual analytics
- Ability to track and analyze data

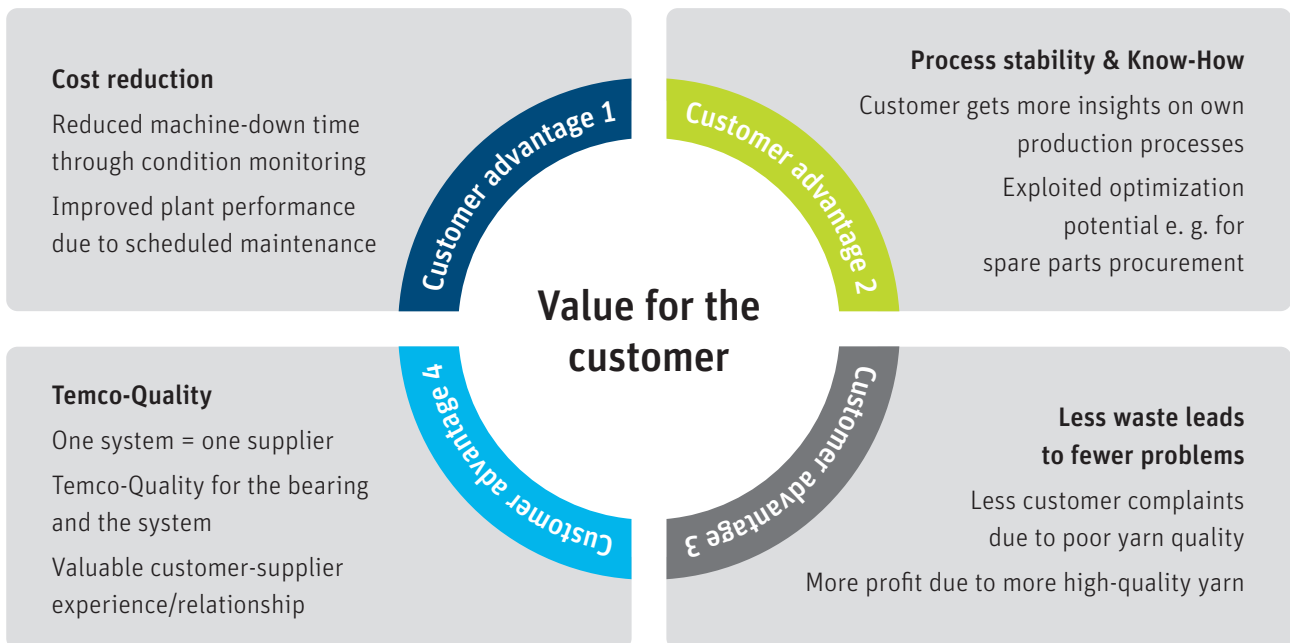

## Energy harvesting and wireless data transfer

The Sensors and energy supply are directly integrated into the bearing arrangement. No external power supply or battery is needed due to the own energy harvesting. Power is generated via a rotating cap with integrated magnets in combination with a fixed coil. The measurement of speed, bearing vibrations and temperature is set up directly on the inner ring of the bearing.

The measured data is transmitted via Bluetooth to a gateway, from where the data is forwarded via Ethernet to an analysis device.

### VR60240 Separator Roller with i-Bearing wireless

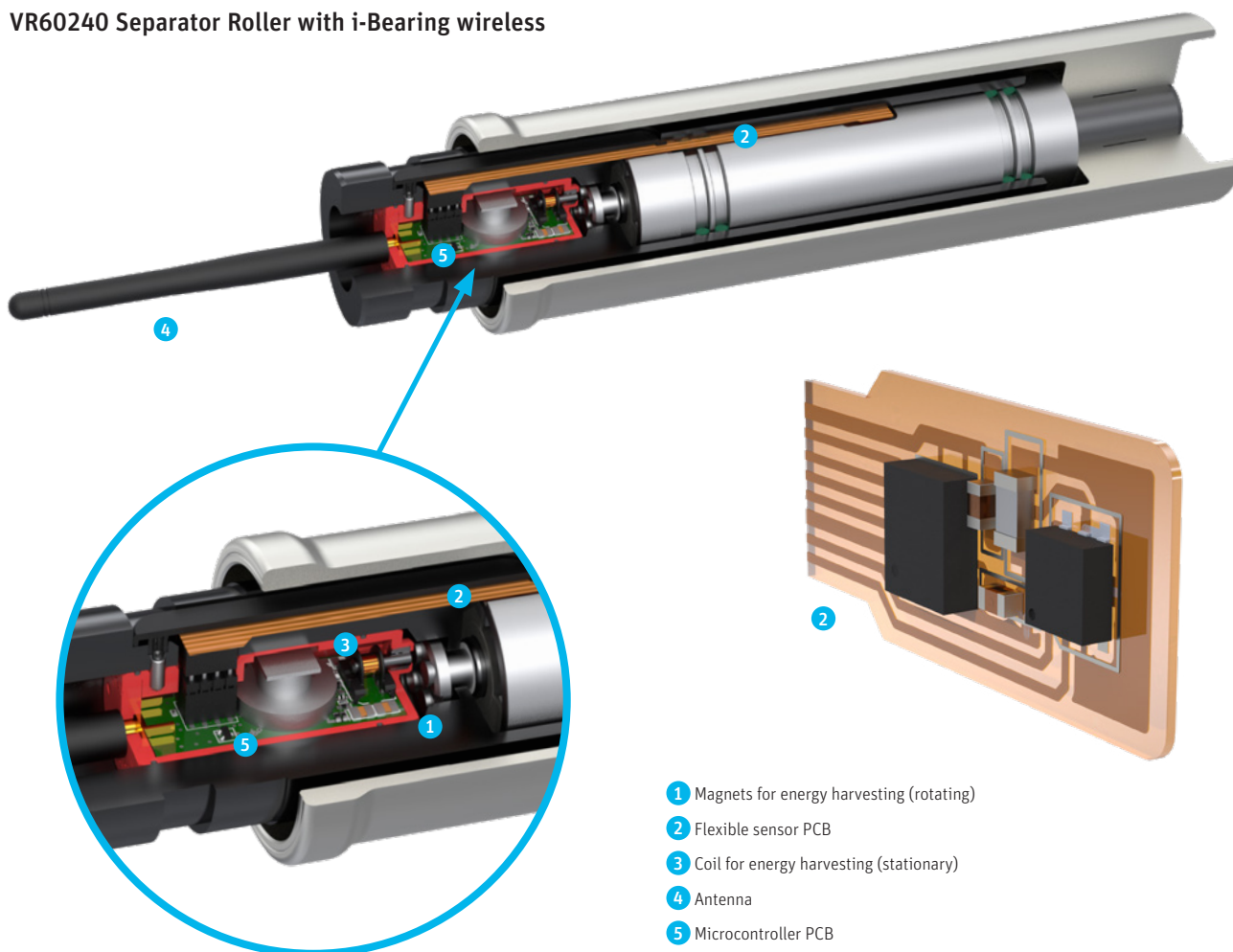

# Experience Goes Digital

## Wireless data transfer via Bluetooth mesh

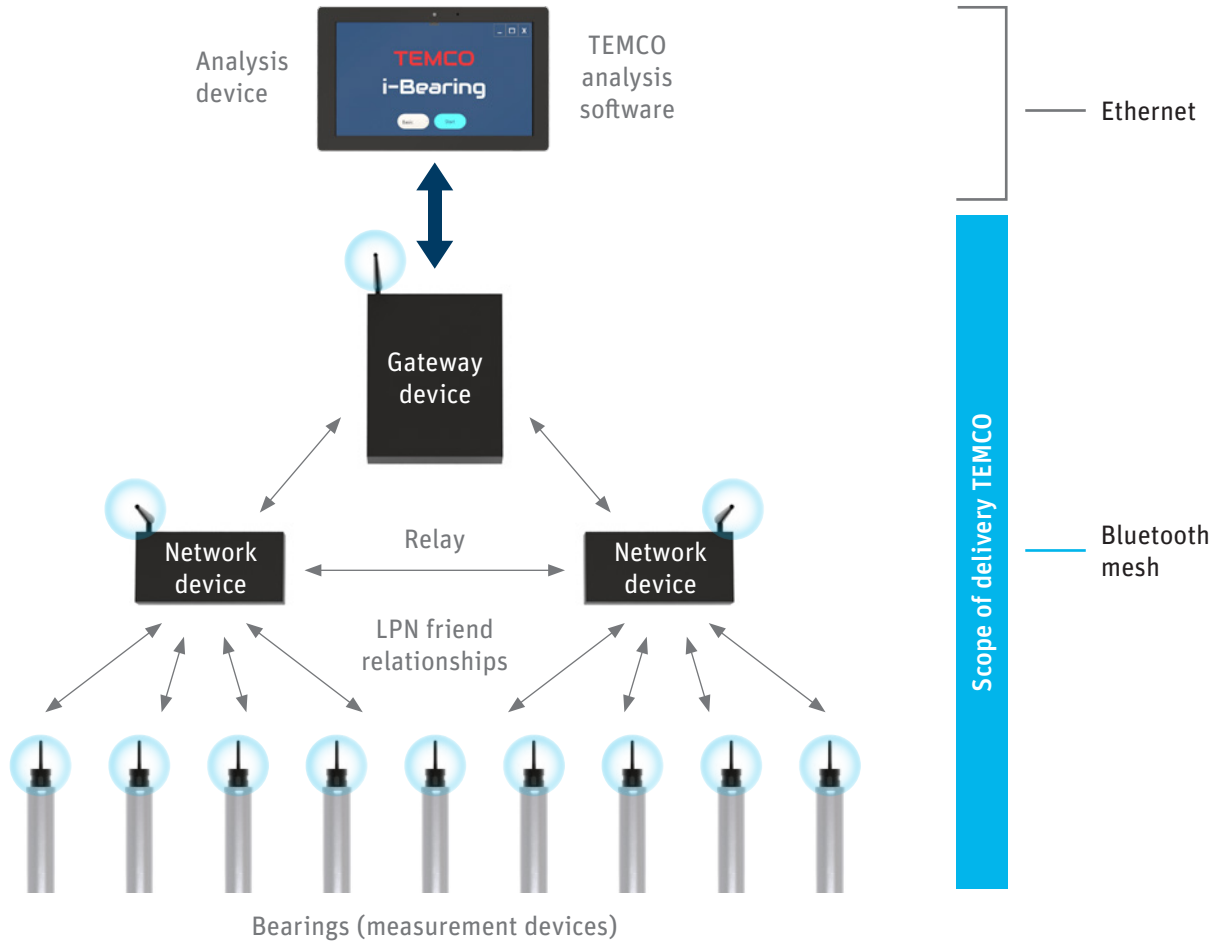

## Features

- Bearings and network / gateway devices form a Bluetooth mesh
- Network devices are used to extend the radio range, e. g. for large networks
- Gateway device can communicate directly with the bearings
- Gateway device functions as interface between Bluetooth and analysis device (PC)
- Connection between PC and gateway via Ethernet

## Temco analysis software

Temco has developed its own analysis software for i-Bearing, which customers can install on a PC or tablet. This software gives a perfect overview of all bearing arrangements in the machine. The bearing condition is indicated by the colors Green (bearing condition good), Yellow (bearing condition to monitor) and Red (bearing must be replaced).

Based on the bearing ID, the machine position can be easily assigned. The software is extremely easy to use and can be adjusted to suit individual needs. In addition, it has different user modes (Basic, Plot, Settings) as well as different diagrams (history diagram and scatterplot).

The intelligence of the i-Bearing allows the constant condition monitoring of every single Temco bearing installed within a plant. By measuring speed, vibration acceleration and temperatures, the i-Bearing identifies critical conditions allowing bearings to be replaced before they fail. Machine maintenance is thus optimized and expensive downtime minimized. Customers also get a clear overview, 24/7, of the condition of all installed Temco bearings across their entire plant.

With this wireless and self-powered version of its i-Bearing, Temco provides more freedom to its bearing condition monitoring system.

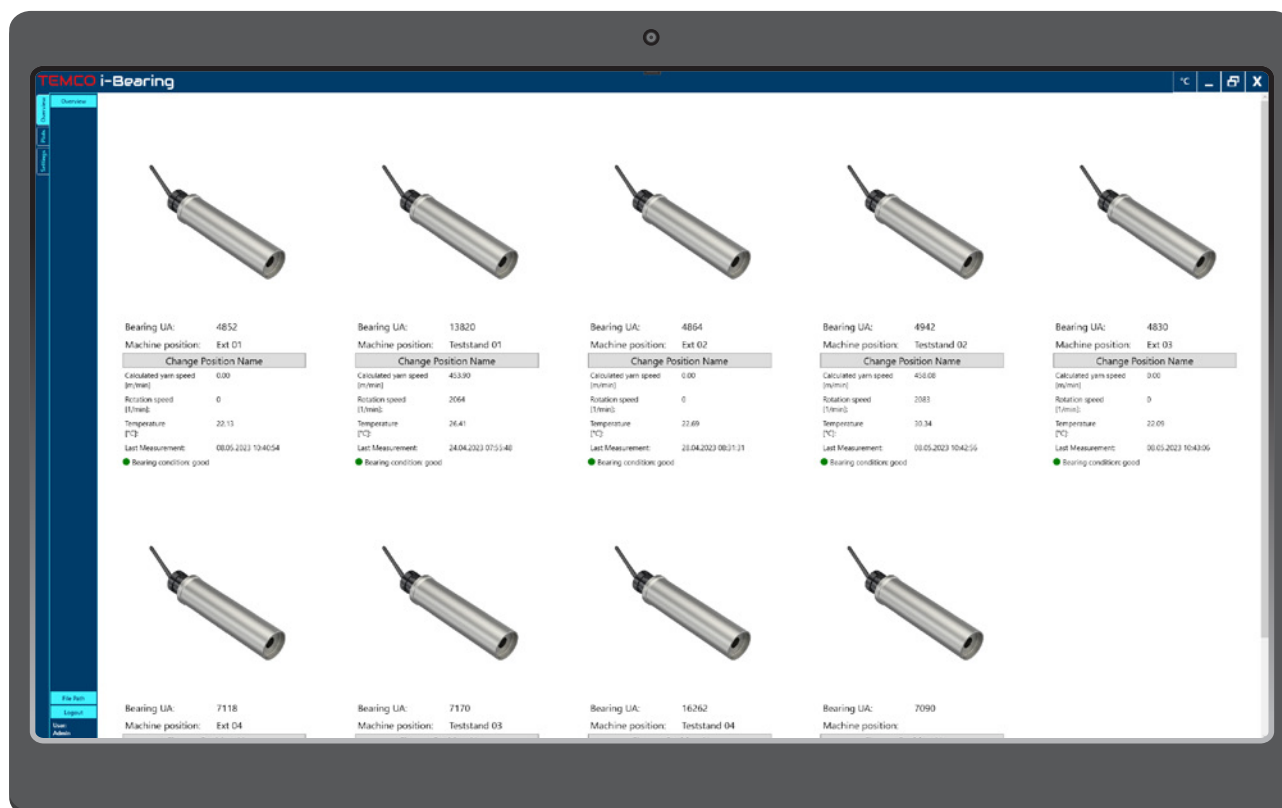

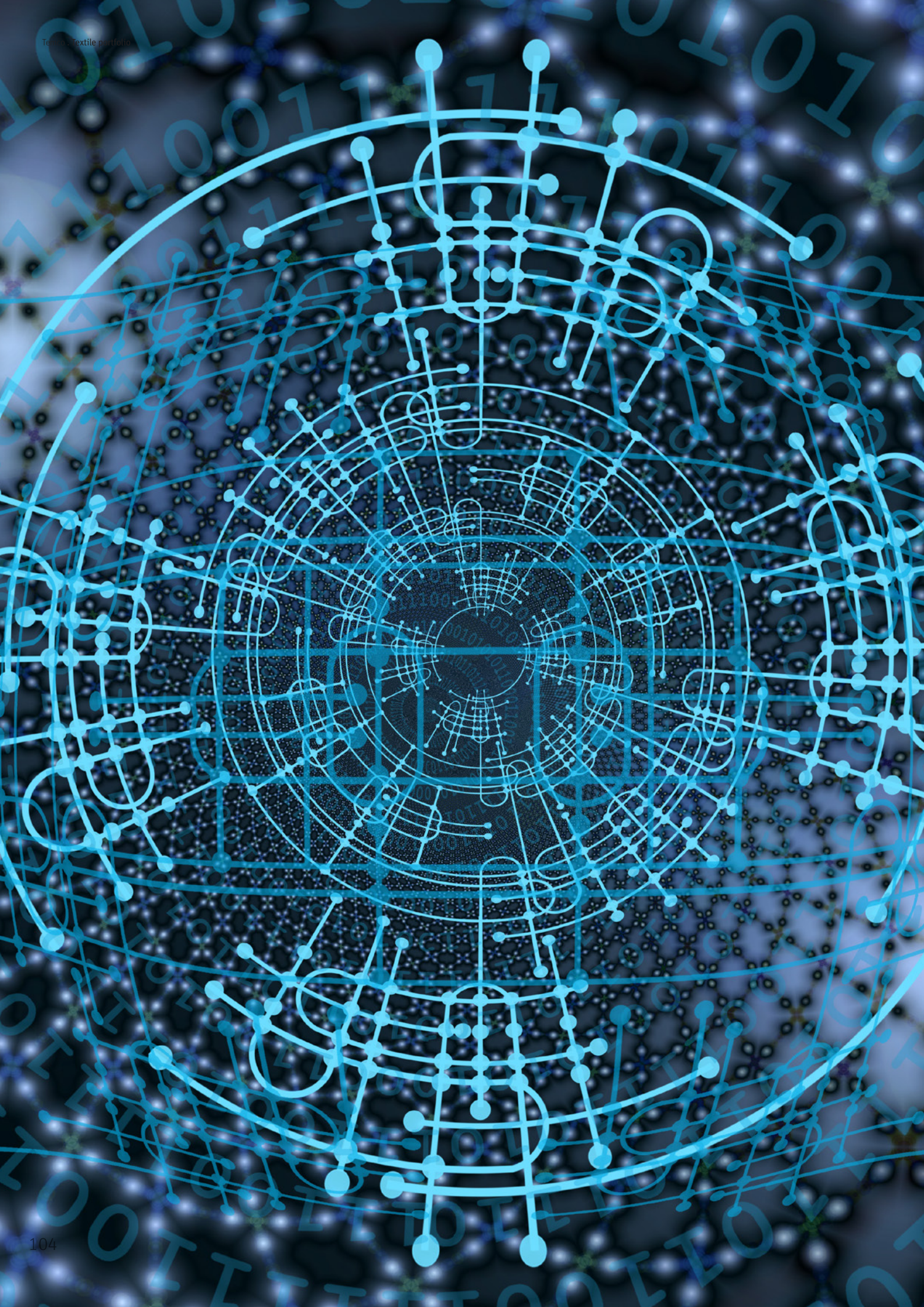



# Coming next?!

The Temco research and development team meets the specific and targeted requirements of the market and creates efficient production solutions together with the customer. Experience, rethinking, creativity and vision - this combination is what makes Temco, and in turn every application, special.

Accordingly, Temco is constantly developing into forward-looking products - whether to create more sustainability or to specifically meet customers' upcoming requirements. Intelligent products for rapid fault detection and thus for avoiding machine downtimes are already well advanced in development.

Temco is also focusing on new ideas when it comes to sustainability. Within the company, Temco is increasingly focusing on recyclable packaging in shipping, energy-saving measures throughout the company, and the avoidance of superfluous waste. New solutions are also increasingly being developed in product development to significantly reduce CO<sup>2</sup> emissions.



**Rieter Components Germany GmbH**

Temco

Fuldaer Strasse 19

97762 Hammelburg

Germany

T +49 (0)9732 87 0

info@temco.de

[www.temco.de](http://www.temco.de)

The data and illustrations in this brochure and on the corresponding data carrier refer to the date of printing. Temco reserves the right to make any necessary changes at any time and without special notice. Temco systems and Temco innovations are protected by patents.

3469-v2 en 2311